



- ★ Green Device Available
- ★ Super Low Gate Charge
- ★ ESD Protection
- ★ Excellent Cdv/dt effect decline
- ★ Advanced high cell density Trench

Product Summary

BVDSS	RDSON	ID
20V	23.5mΩ	5.5A

Description

The FKQ2721 is the low RDSON trenched N-CH MOSFETs with robust ESD protection. This product is suitable for Lithium-ion battery pack applications.

The FKQ2721 meet the RoHS and Green Product requirement with full function reliability approved.

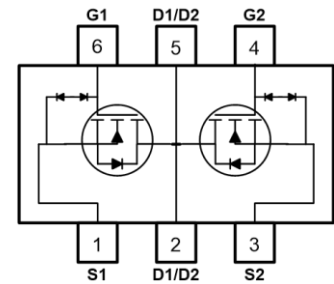
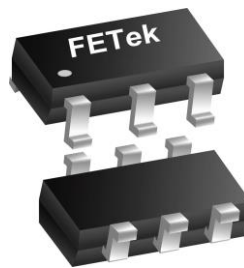
TSOP6 Pin Configuration

Absolute Maximum Ratings

Symbol	Parameter	Rating	Units
V_{DS}	Drain-Source Voltage	20	V
V_{GS}	Gate-Source Voltage	± 12	V
$I_D @ T_A = 25^\circ C$	Continuous Drain Current ¹	5.5	A
$I_D @ T_A = 70^\circ C$	Continuous Drain Current ¹	4.4	A
I_{DM}	Pulsed Drain Current ²	22	A
$P_D @ T_A = 25^\circ C$	Total Power Dissipation ³	1.25	W
T_{STG}	Storage Temperature Range	-55 to 150	$^\circ C$
T_J	Operating Junction Temperature Range	-55 to 150	$^\circ C$

Thermal Data

Symbol	Parameter	Typ.	Max.	Unit
$R_{\theta JA}$	Thermal Resistance Junction-ambient ¹	---	100	$^\circ C/W$

**N-Channel Electrical Characteristics (T_J=25 °C, unless otherwise noted)**

Symbol	Parameter	Conditions	Min.	Typ.	Max.	Unit
BV _{DSS}	Drain-Source Breakdown Voltage	V _{GS} =0V, I _D =250uA	20	---	---	V
R _{DS(ON)}	Static Drain-Source On-Resistance ²	V _{GS} =4.5V, I _D =2.75A	17.5	20.5	23.5	mΩ
		V _{GS} =4.0V, I _D =2.75A	18.5	21.5	24.5	
		V _{GS} =3.7V, I _D =2.75A	19.0	22.5	26.5	
		V _{GS} =3.1V, I _D =2.75A	19.5	24.5	29.5	
		V _{GS} =2.5V, I _D =2.75A	21.5	28.5	35.5	
V _{GS(th)}	Gate Threshold Voltage	V _{GS} =V _{DS} , I _D =250uA	0.5	0.7	1.2	V
I _{DSS}	Drain-Source Leakage Current	V _{DS} =16V, V _{GS} =0V, T _J =25°C	---	---	1	uA
		V _{DS} =16V, V _{GS} =0V, T _J =55°C	---	---	5	
I _{GSS}	Gate-Source Leakage Current	V _{GS} =±8V, V _{DS} =0V	---	---	±10	uA
g _{fs}	Forward Transconductance	V _{DS} =5V, I _D =3A	---	18	---	S
Q _g	Total Gate Charge	V _{DS} =15V, V _{GS} =4.5V, I _D =6A	---	10.4	---	nC
Q _{gs}	Gate-Source Charge		---	1.6	---	
Q _{gd}	Gate-Drain Charge		---	2.9	---	
T _{d(on)}	Turn-On Delay Time	V _{DD} =10V, V _{GS} =4.5V, R _G =3.3Ω I _D =3A	---	3.4	---	ns
T _r	Rise Time		---	11.0	---	
T _{d(off)}	Turn-Off Delay Time		---	35	---	
T _f	Fall Time		---	4.2	---	
C _{iss}	Input Capacitance	V _{DS} =15V, V _{GS} =0V, f=1MHz	---	635	---	pF
C _{oss}	Output Capacitance		---	67	---	
C _{rss}	Reverse Transfer Capacitance		---	61	---	

Diode Characteristics

Symbol	Parameter	Conditions	Min.	Typ.	Max.	Unit
I _S	Continuous Source Current ^{1,4}	V _G =V _D =0V, Force Current	---	---	5.5	A
V _{SD}	Diode Forward Voltage ²	V _{GS} =0V, I _S =1A, T _J =25°C	---	0.75	1.2	V

Note :

1. The data tested by surface mounted on a 1 inch² FR-4 board with 2OZ copper, t ≤ 10s.
2. The data tested by pulsed, pulse width ≤ 300us, duty cycle ≤ 2%
3. The power dissipation is limited by 150°C junction temperature
4. The data is theoretically the same as I_D and I_{DM}, in real applications, should be limited by total power dissipation.

N-Channel Typical Characteristics

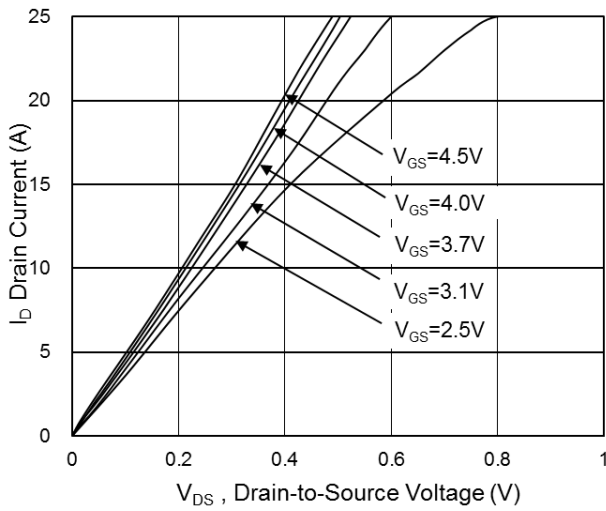

Fig.1 Typical Output Characteristics

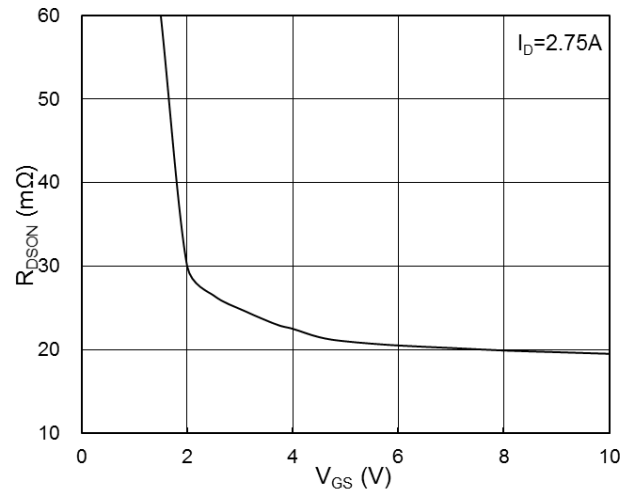

Fig.2 On-Resistance vs. G-S voltage

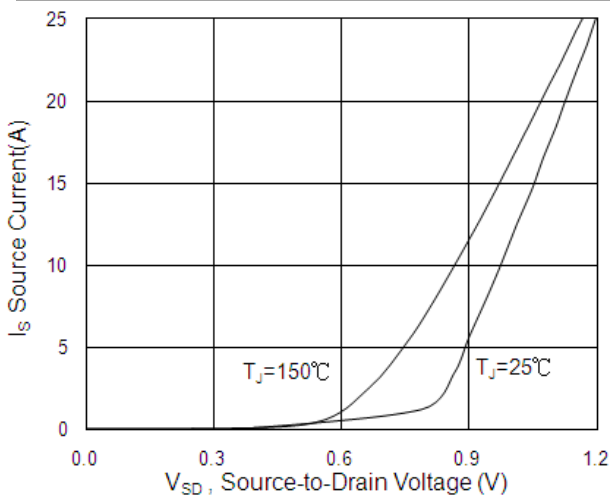

Fig.3 Forward Characteristics of Reverse

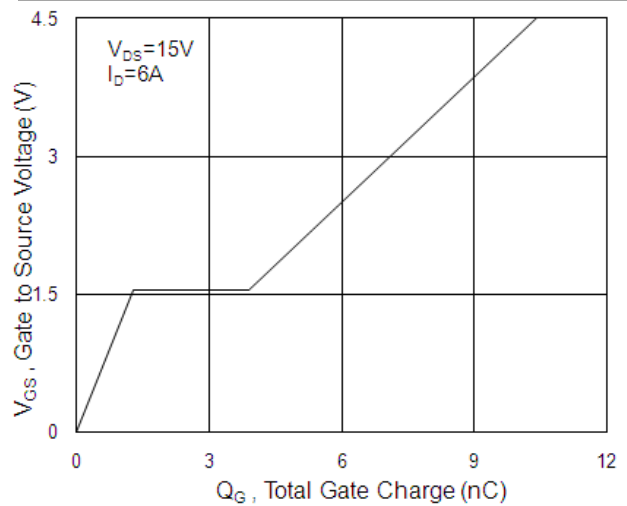

Fig.4 Gate-Charge Characteristics

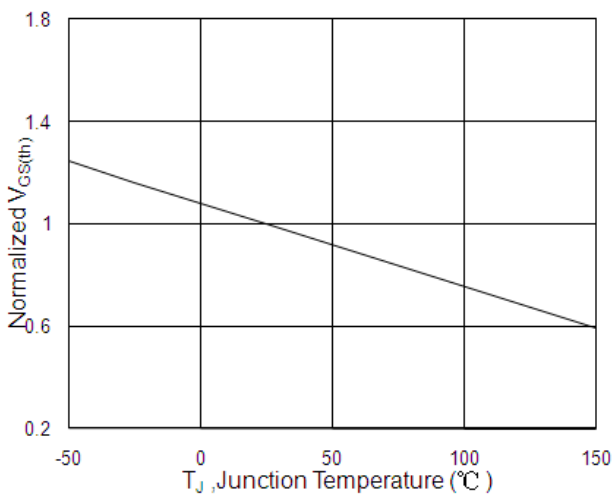

Fig.5 Normalized V_{GS(th)} vs. T_J

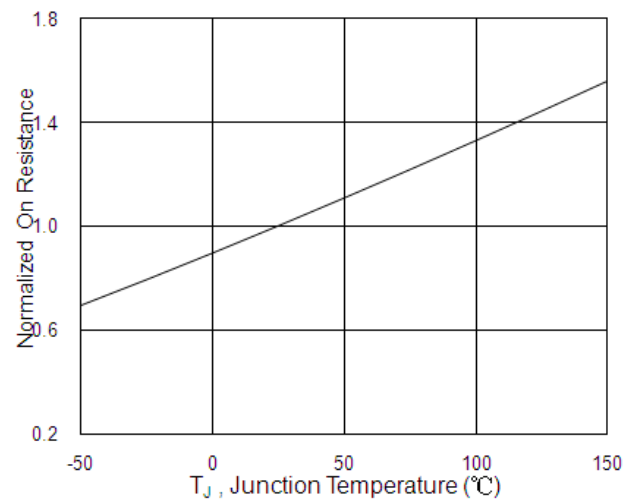

Fig.6 Normalized R_{DS(on)} vs. T_J

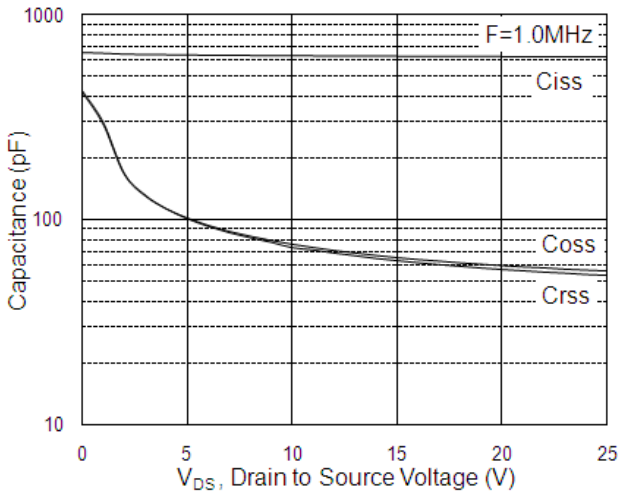

Fig.7 Capacitance

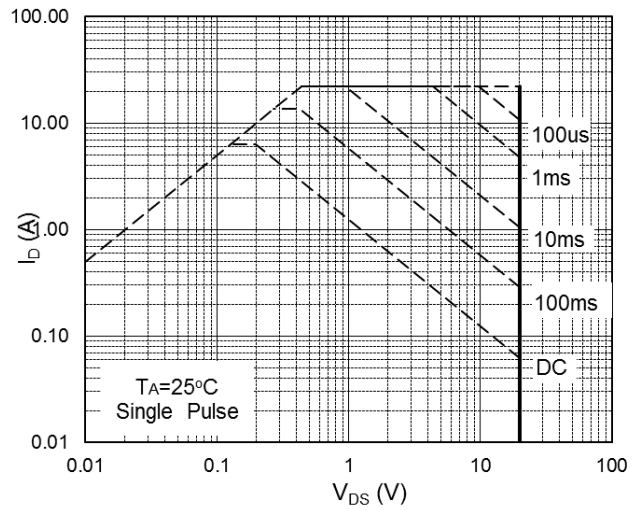

Fig.8 Safe Operating Area

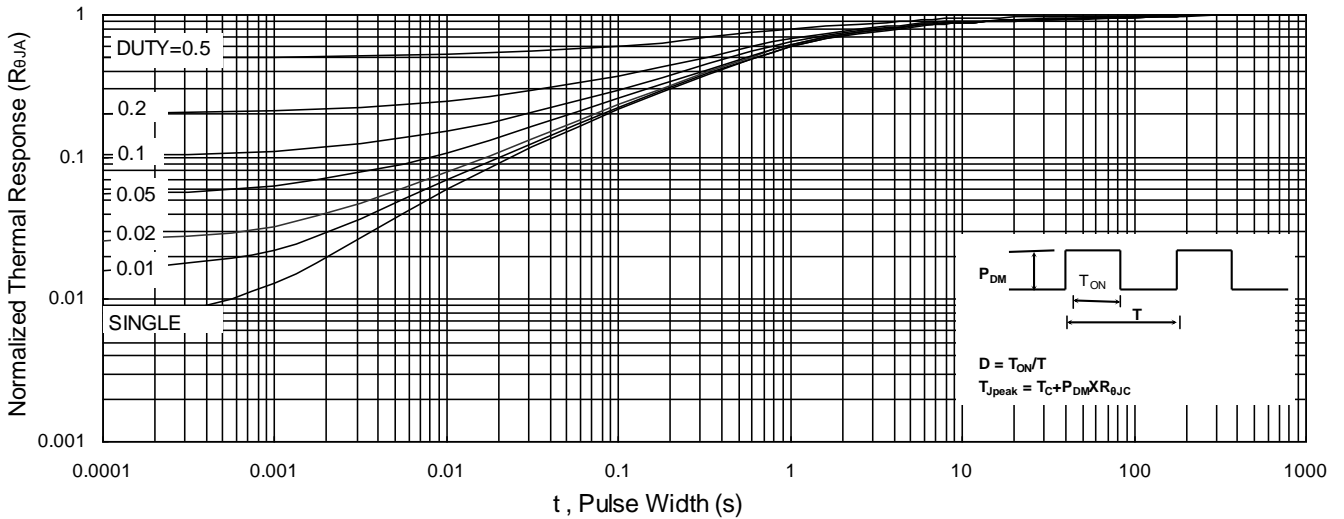

Fig.9 Normalized Maximum Transient Thermal Impedance

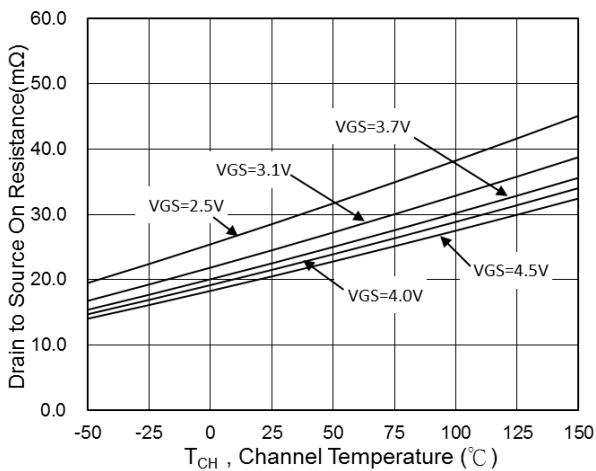
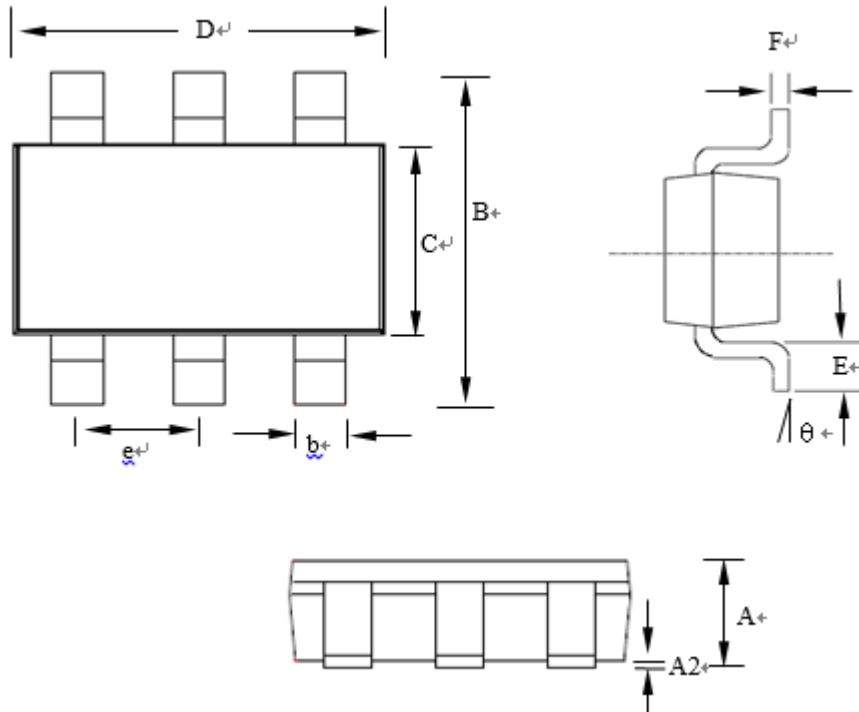

Fig.10 On-Resistance vs. Channel Temperature

TSOP6 Package Outline Dimensions



SYMBOLS	MILLIMETERS [⊕]			INCHES [⊕]		
	MIN [⊕]	NOM [⊕]	MAX [⊕]	MIN [⊕]	NOM [⊕]	MAX [⊕]
A [⊕]	0.70 [⊕]	-- [⊕]	0.9 [⊕]	0.028 [⊕]	-- [⊕]	0.035 [⊕]
A2 [⊕]	0.00 [⊕]	-- [⊕]	0.10 [⊕]	0.000 [⊕]	-- [⊕]	0.004 [⊕]
B [⊕]	2.60 [⊕]	2.80 [⊕]	3.00 [⊕]	0.102 [⊕]	0.110 [⊕]	0.118 [⊕]
C [⊕]	1.40 [⊕]	1.60 [⊕]	1.80 [⊕]	0.055 [⊕]	0.063 [⊕]	0.071 [⊕]
D [⊕]	2.70 [⊕]	2.90 [⊕]	3.10 [⊕]	0.106 [⊕]	0.114 [⊕]	0.122 [⊕]
E [⊕]	0.30 [⊕]	0.40 [⊕]	0.60 [⊕]	0.012 [⊕]	0.016 [⊕]	0.024 [⊕]
F [⊕]	0.07 [⊕]	0.127 [⊕]	0.20 [⊕]	0.003 [⊕]	0.005 [⊕]	0.008 [⊕]
b [⊕]	0.30 [⊕]	0.40 [⊕]	0.50 [⊕]	0.012 [⊕]	0.016 [⊕]	0.020 [⊕]
e [⊕]	-- [⊕]	0.95 [⊕]	-- [⊕]	-- [⊕]	0.037 [⊕]	-- [⊕]
θ^{\oplus}	0° [⊕]	5° [⊕]	10° [⊕]	0° [⊕]	5° [⊕]	10° [⊕]

Marking Instruction

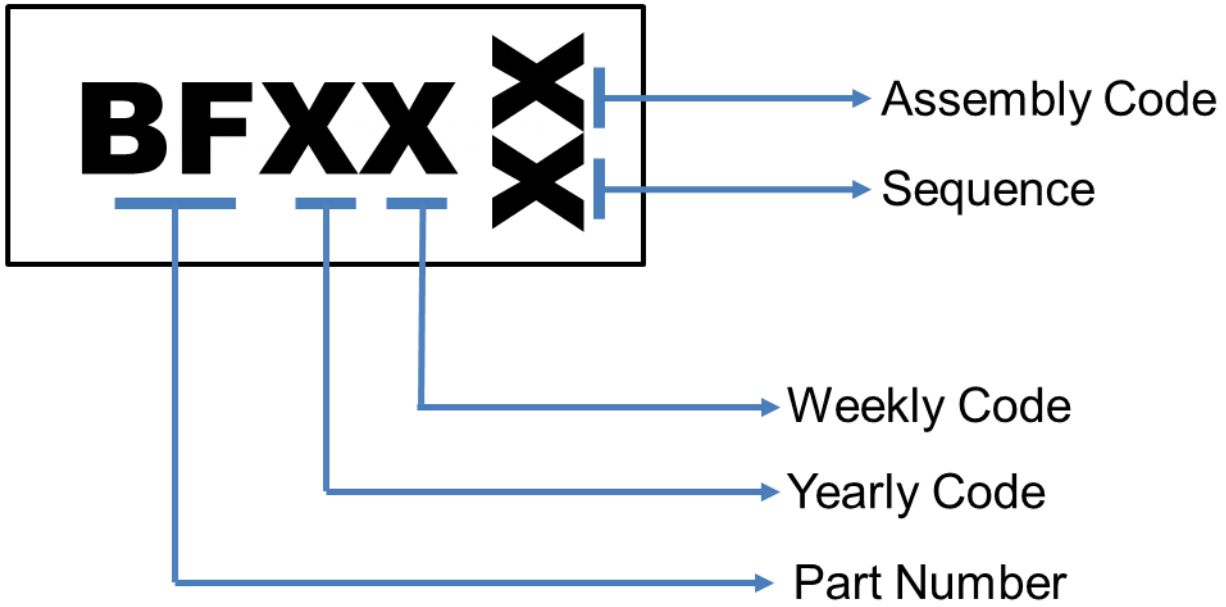

TSOP6 Tape and Reel Data

