

Description

- ★ Advanced Trench MOS Technology
- ★ 100% EAS Guaranteed
- ★ Green Device Available

Product Summary

BVDSS	RDSON	ID
60V	4.5mΩ	120A

Applications

- ★ DC-DC Converter.
- ★ Motor Control.
- ★ Load Switching.
- ★ Secondary Side Synchronous Rectification.

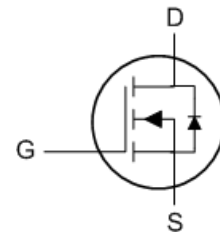
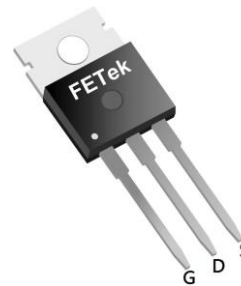
TO220 Pin Configuration

Absolute Maximum Ratings

Symbol	Parameter	Rating	Units
V_{DS}	Drain-Source Voltage	60	V
V_{GS}	Gate-Source Voltage	± 20	V
$I_D@T_C=25^\circ C$	Continuous Drain Current ^{1,6}	120	A
$I_D@T_C=100^\circ C$	Continuous Drain Current ^{1,6}	85	A
I_{DM}	Pulsed Drain Current ²	400	A
EAS	Single Pulse Avalanche Energy ³	48	mJ
I_{AS}	Avalanche Current	31	A
$P_D@T_C=25^\circ C$	Total Power Dissipation ⁴	136	W
T_{STG}	Storage Temperature Range	-55 to 175	$^\circ C$
T_J	Operating Junction Temperature Range	-55 to 175	$^\circ C$

Thermal Data

Symbol	Parameter	Typ.	Max.	Unit
$R_{\theta JA}$	Thermal Resistance Junction-Ambient ¹	---	50	$^\circ C/W$
$R_{\theta JA}$	Thermal Resistance Junction-Ambient ^{1, t ≤ 10s}	---	18	$^\circ C/W$
$R_{\theta JC}$	Thermal Resistance Junction-Case ¹	---	1.1	$^\circ C/W$

Electrical Characteristics ($T_J=25^\circ\text{C}$, unless otherwise noted)

Symbol	Parameter	Conditions	Min.	Typ.	Max.	Unit
BV_{DSS}	Drain-Source Breakdown Voltage	$V_{GS}=0V, I_D=250\mu A$	60	---	---	V
$R_{DS(ON)}$	Static Drain-Source On-Resistance ²	$V_{GS}=10V, I_D=20A$	---	---	4.5	m Ω
		$V_{GS}=4.5V, I_D=15A$	---	---	6.5	m Ω
$V_{GS(th)}$	Gate Threshold Voltage	$V_{GS}=V_{DS}, I_D=250\mu A$	1.2	---	2.3	V
I_{DSS}	Drain-Source Leakage Current	$V_{DS}=48V, V_{GS}=0V, T_J=25^\circ\text{C}$	---	---	1	μA
		$V_{DS}=48V, V_{GS}=0V, T_J=55^\circ\text{C}$	---	---	5	
I_{GSS}	Gate-Source Leakage Current	$V_{GS}=\pm 20V, V_{DS}=0V$	---	---	± 100	nA
g_{fs}	Forward Transconductance	$V_{DS}=5V, I_D=20A$	---	65	---	S
R_g	Gate Resistance	$V_{DS}=0V, V_{GS}=0V, f=1\text{MHz}$	---	0.9	---	Ω
Q_g	Total Gate Charge (10V)	$V_{DS}=30V, V_{GS}=10V, I_D=20A$	---	58	---	nC
Q_{gs}	Gate-Source Charge		---	16	---	
Q_{gd}	Gate-Drain Charge		---	4	---	
$T_{d(on)}$	Turn-On Delay Time	$V_{DD}=30V, V_{GS}=10V, R_G=3\Omega, I_D=20A$	---	18	---	ns
T_r	Rise Time		---	8	---	
$T_{d(off)}$	Turn-Off Delay Time		---	50	---	
T_f	Fall Time		---	10.5	---	
C_{iss}	Input Capacitance	$V_{DS}=30V, V_{GS}=0V, f=1\text{MHz}$	---	3458	---	μF
C_{oss}	Output Capacitance		---	1522	---	
C_{rss}	Reverse Transfer Capacitance		---	22	---	

Diode Characteristics

Symbol	Parameter	Conditions	Min.	Typ.	Max.	Unit
I_S	Continuous Source Current ^{1,5,6}	$V_G=V_D=0V$, Force Current	---	---	100	A
V_{SD}	Diode Forward Voltage ²	$V_{GS}=0V, I_S=1A, T_J=25^\circ\text{C}$	---	---	1.2	V
t_{rr}	Reverse Recovery Time	$I_F=20A, di/dt=100A/\mu s, T_J=25^\circ\text{C}$	---	24	---	nS
Q_{rr}	Reverse Recovery Charge		---	85	---	nC

Note :

- The data tested by surface mounted on a 1 inch² FR-4 board with 2OZ copper.
- The data tested by pulsed, pulse width $\leq 300\mu s$, duty cycle $\leq 2\%$
- The EAS data shows Max. rating. The test condition is $V_{DD}=25V, V_{GS}=10V, L=0.1mH, I_{AS}=31A$
- The power dissipation is limited by 150°C junction temperature
- The data is theoretically the same as I_D and I_{DM} , in real applications, should be limited by total power dissipation.
- Bonding wire limitation current is 85A.

Typical Characteristics

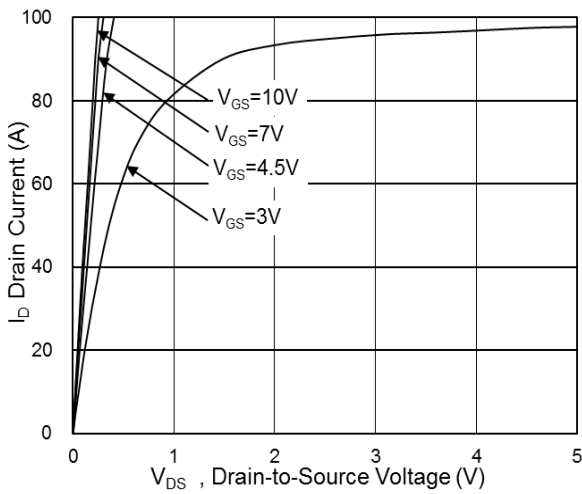

Fig.1 Typical Output Characteristics

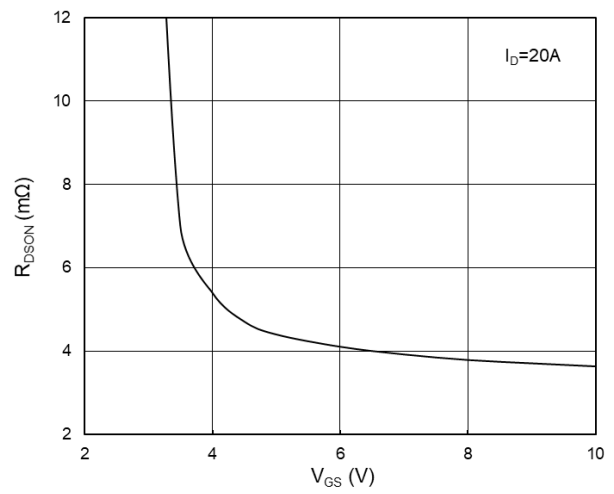

Fig.2 On-Resistance vs G-S Voltage

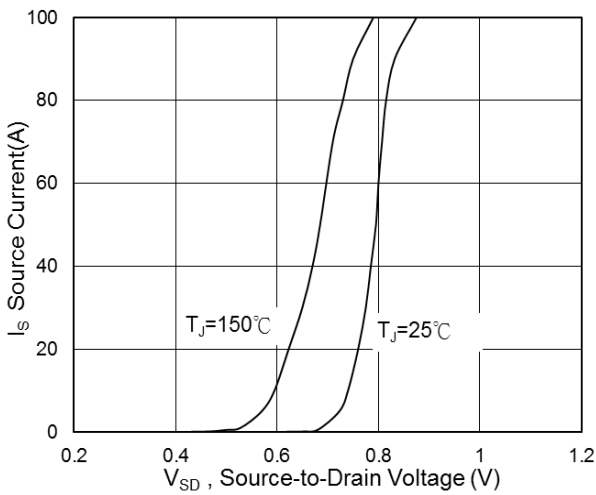

Fig.3 Source Drain Forward Characteristics

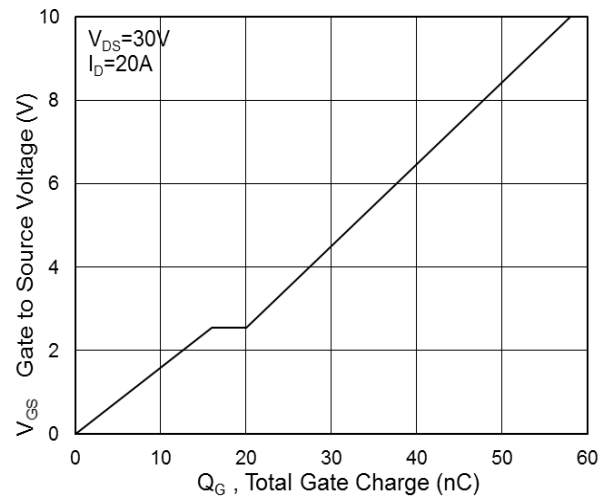

Fig.4 Gate-Charge Characteristics

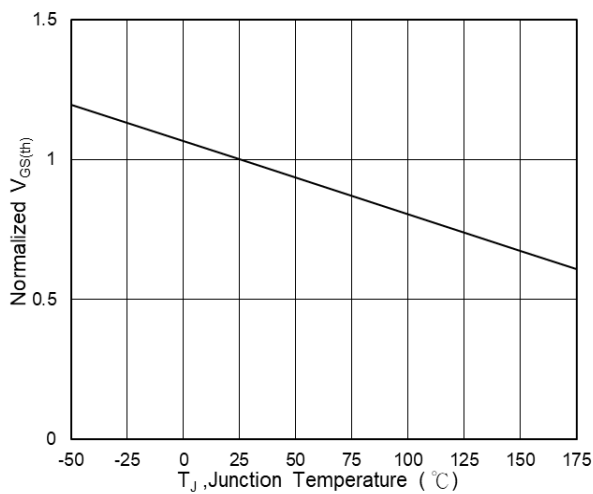

Fig.5 Normalized $V_{GS(th)}$ vs T_J

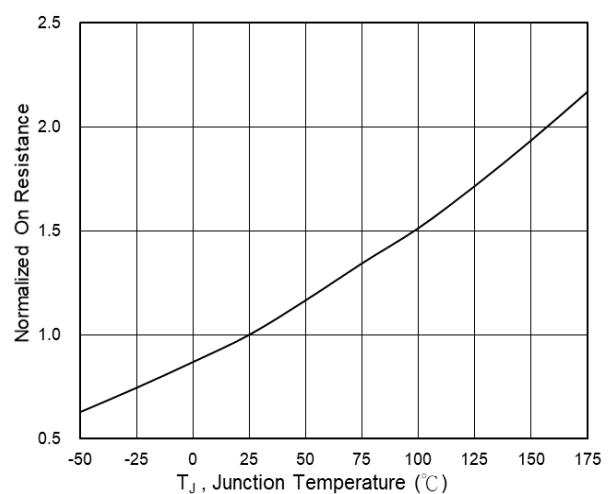

Fig.6 Normalized $R_{DS(on)}$ vs T_J

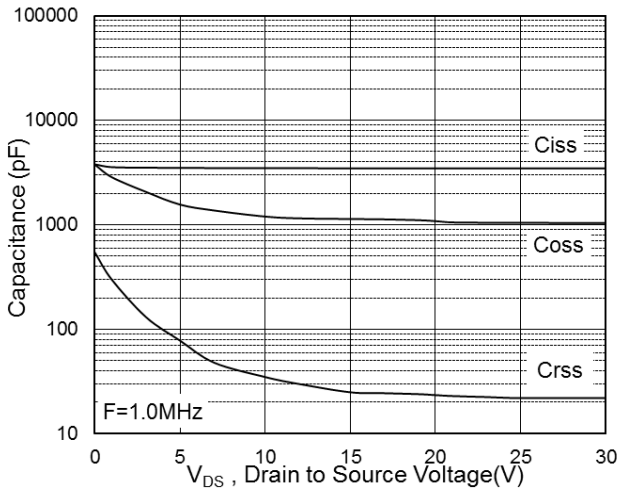

Fig.7 Capacitance

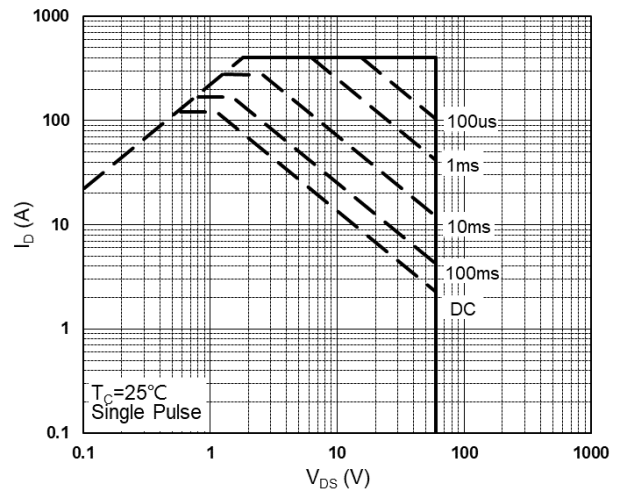

Fig.8 Safe Operating Area

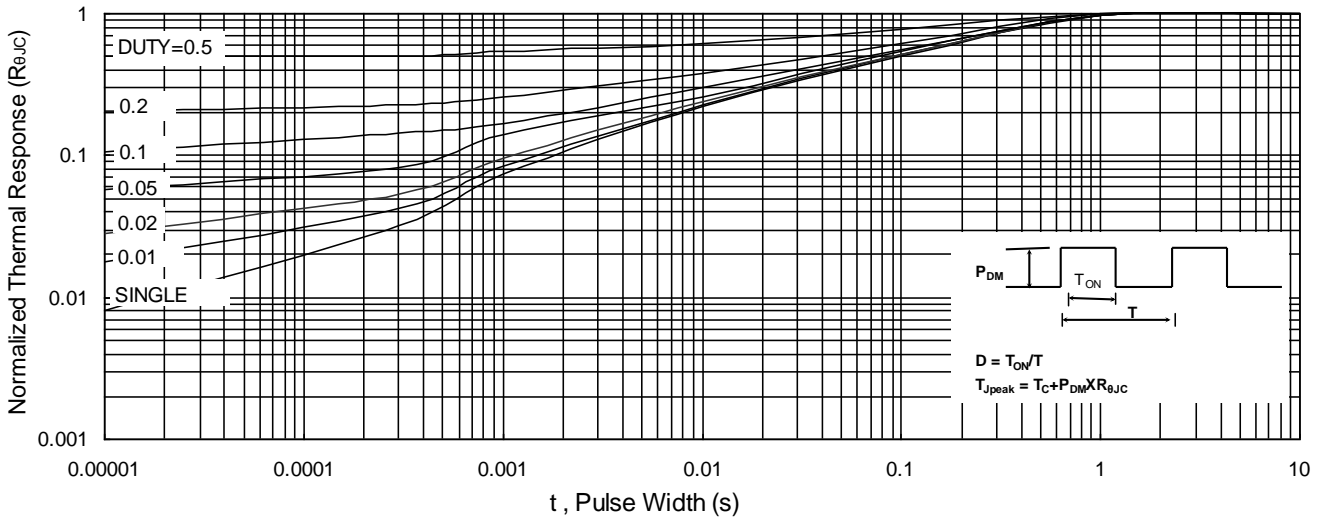

Fig.9 Normalized Maximum Transient Thermal Impedance

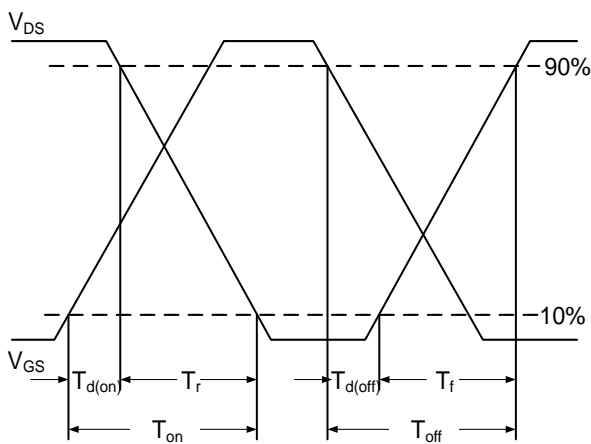

Fig.10 Switching Time Waveform

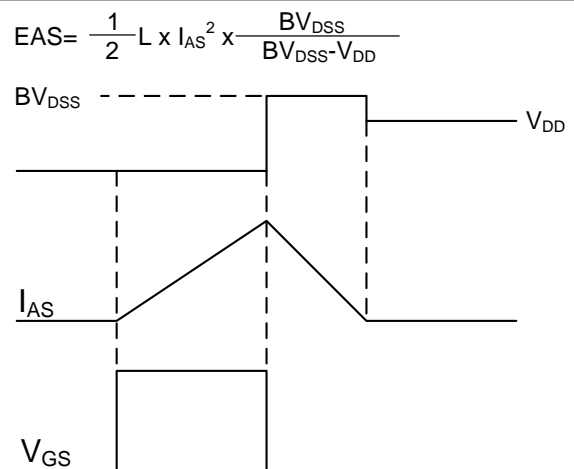

Fig.11 Unclamped Inductive Switching Waveform