

General Description

- Advanced Trench MOS Technology
- Low Gate Charge
- LOW $R_{DS(ON)}$
- 100% EAS Guaranteed
- Green Device Available

Applications

- SMPS Synchronous Rectification
- DC/DC Converters
- Or-ing

Product Summary

BVDSS	RDSON	ID
40V	2.8mΩ	170A

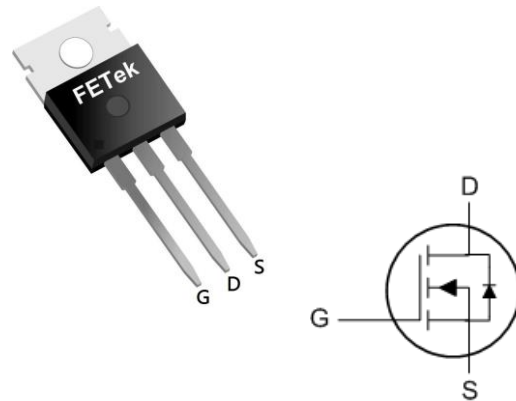
TO220 Pin Configuration

Absolute Maximum Ratings

Symbol	Parameter	Rating	Units
V_{DS}	Drain-Source Voltage	40	V
V_{GS}	Gate-Source Voltage	± 20	V
$I_D @ T_C=25^\circ C$	Continuous Drain Current, $V_{GS} @ 10V^{1,6}$	170	A
$I_D @ T_C=100^\circ C$	Continuous Drain Current, $V_{GS} @ 10V^{1,6}$	142	A
I_{DM}	Pulsed Drain Current ²	340	A
EAS	Single Pulse Avalanche Energy ³	320	mJ
I_{AS}	Avalanche Current	80	A
$P_D @ T_C=25^\circ C$	Total Power Dissipation ⁴	178	W
T_{STG}	Storage Temperature Range	-55 to 150	$^\circ C$
T_J	Operating Junction Temperature Range	-55 to 150	$^\circ C$

Thermal Data

Symbol	Parameter	Typ.	Max.	Unit
$R_{\theta JA}$	Thermal Resistance Junction-Ambient ¹	---	50	$^\circ C/W$
$R_{\theta JC}$	Thermal Resistance Junction-Case ¹	---	0.7	$^\circ C/W$

**Electrical Characteristics (T_J=25 °C, unless otherwise noted)**

Symbol	Parameter	Conditions	Min.	Typ.	Max.	Unit
BV _{DSS}	Drain-Source Breakdown Voltage	V _{GS} =0V, I _D =250uA	40	---	---	V
R _{DS(ON)}	Static Drain-Source On-Resistance ²	V _{GS} =10V, I _D =20A	---	2.4	2.8	mΩ
V _{GS(th)}	Gate Threshold Voltage	V _{GS} =V _{DS} , I _D =250uA	2	2.8	4	V
I _{DSS}	Drain-Source Leakage Current	V _{DS} =32V, V _{GS} =0V, T _J =25°C	---	---	1	uA
		V _{DS} =32V, V _{GS} =0V, T _J =55°C	---	---	5	
I _{GSS}	Gate-Source Leakage Current	V _{GS} =±20V, V _{DS} =0V	---	---	±100	nA
g _{fs}	Forward Transconductance	V _{DS} =5V, I _D =20A	---	53	---	S
R _g	Gate Resistance	V _{DS} =0V, V _{GS} =0V, f=1MHz	---	1.9	---	Ω
Q _g	Total Gate Charge	V _{DS} =20V, V _{GS} =10V, I _D =20A	---	60	---	nC
Q _{gs}	Gate-Source Charge		---	14.7	---	
Q _{gd}	Gate-Drain Charge		---	13.9	---	
T _{d(on)}	Turn-On Delay Time	V _{DD} =20V, V _{GS} =10V, R _G =3Ω, I _D =20A	---	11.4	---	ns
T _r	Rise Time		---	41.6	---	
T _{d(off)}	Turn-Off Delay Time		---	42.8	---	
T _f	Fall Time		---	27.2	---	
C _{iss}	Input Capacitance	V _{DS} =20V, V _{GS} =0V, f=1MHz	---	3739	---	pF
C _{oss}	Output Capacitance		---	1267	---	
C _{rss}	Reverse Transfer Capacitance		---	106	---	

Diode Characteristics

Symbol	Parameter	Conditions	Min.	Typ.	Max.	Unit
I _S	Continuous Source Current ^{1,6}	V _G =V _D =0V, Force Current	---	---	130	A
V _{SD}	Diode Forward Voltage ²	V _{GS} =0V, I _S =1A, T _J =25°C	---	---	1.2	V

Note :

- The data tested by surface mounted on a 1 inch² FR-4 board with 2OZ copper.
- The data tested by pulsed, pulse width ≤ 300us, duty cycle ≤ 2%
- The EAS data shows Max. rating. The test condition is V_{DD}=25V, V_{GS}=10V, L=0.1mH, I_{AS}=80A
- The power dissipation is limited by 150°C junction temperature.
- The data is theoretically the same as I_D and I_{DM}, in real applications, should be limited by total power dissipation.
- Bonding wire limitation current is 85A.

Typical Characteristics

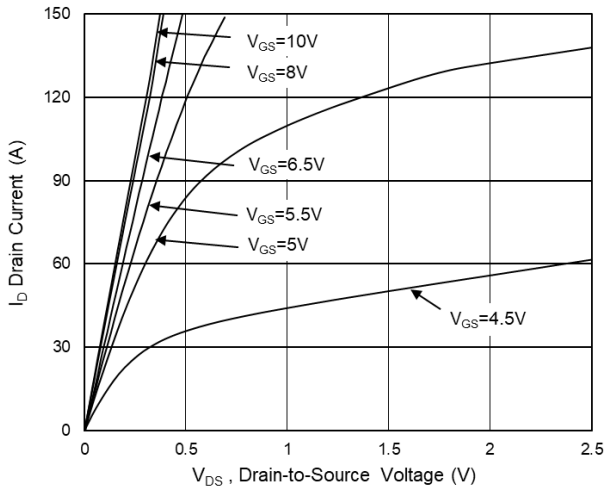

Fig.1 Typical Output Characteristics

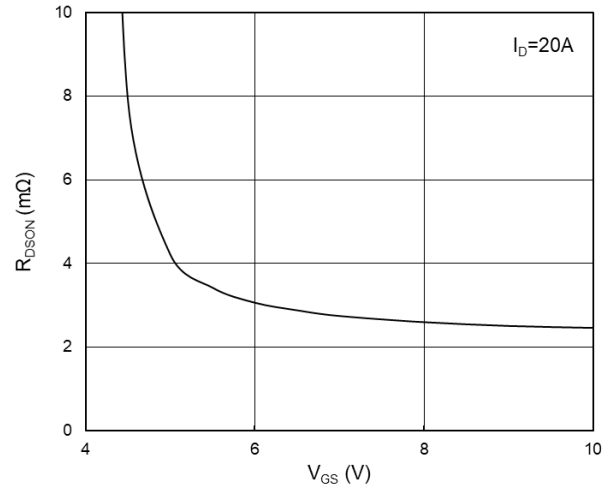

Fig.2 On-Resistance vs G-S Voltage

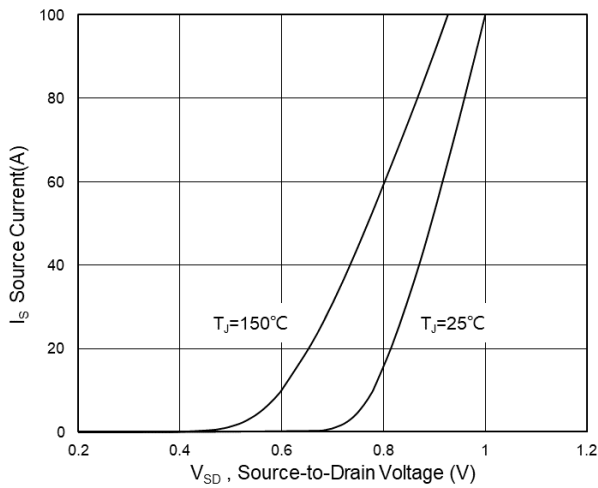

Fig.3 Source Drain Forward Characteristics

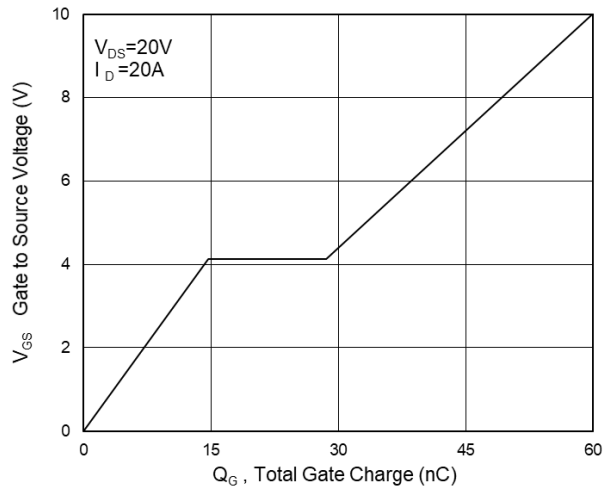

Fig.4 Gate-Charge Characteristics

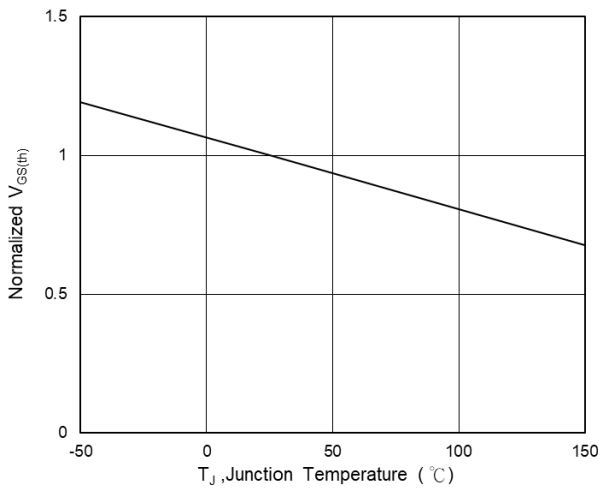

Fig.5 Normalized $V_{GS(th)}$ vs T_J

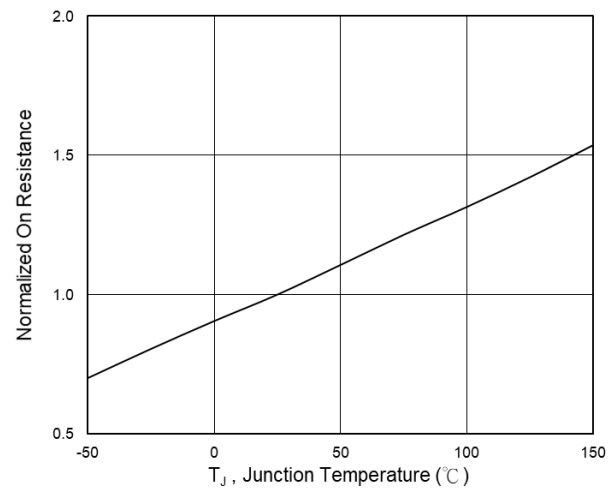

Fig.6 Normalized $R_{DS(on)}$ vs T_J

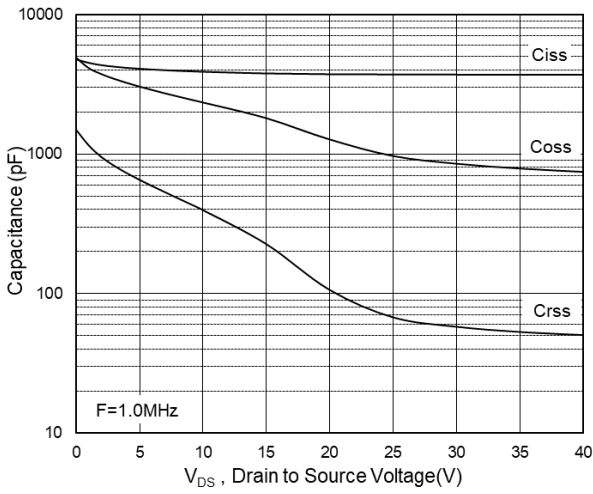

Fig.7 Capacitance

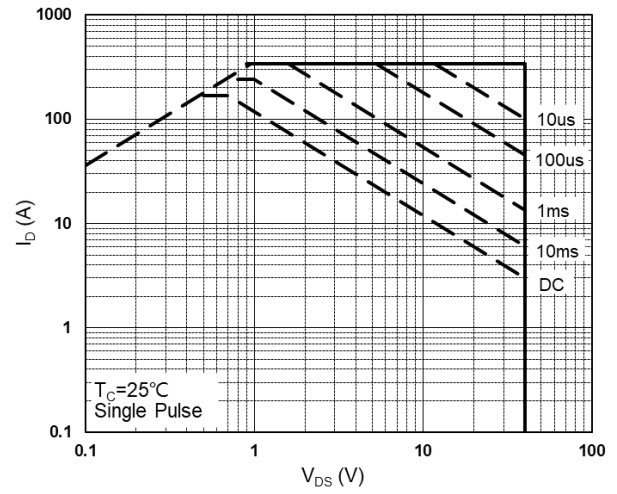

Fig.8 Safe Operating Area

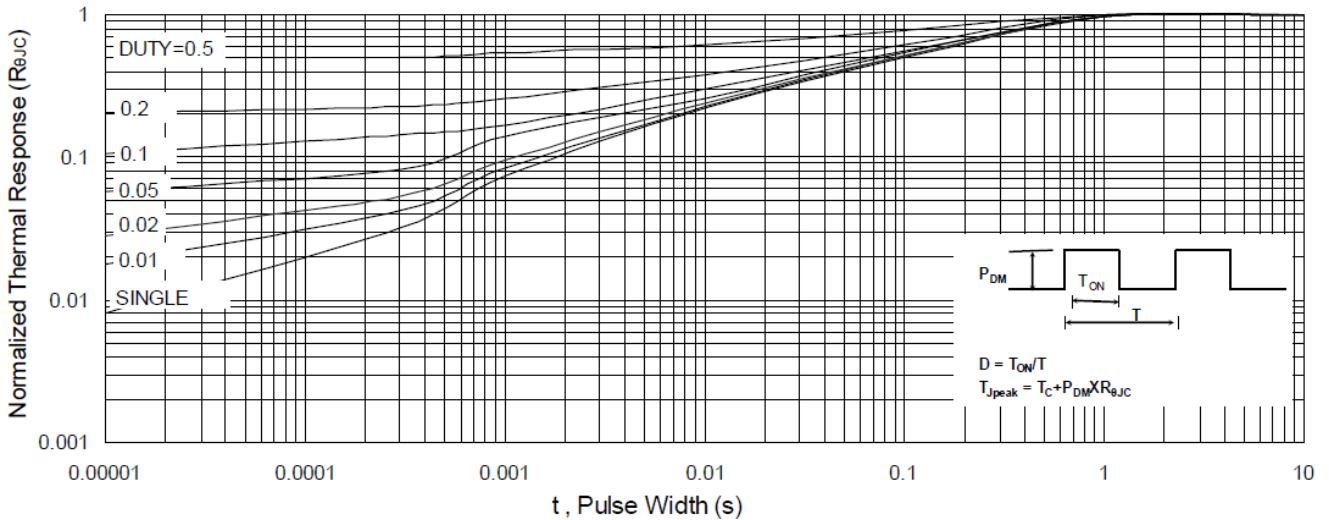

Fig.9 Normalized Maximum Transient Thermal Impedance

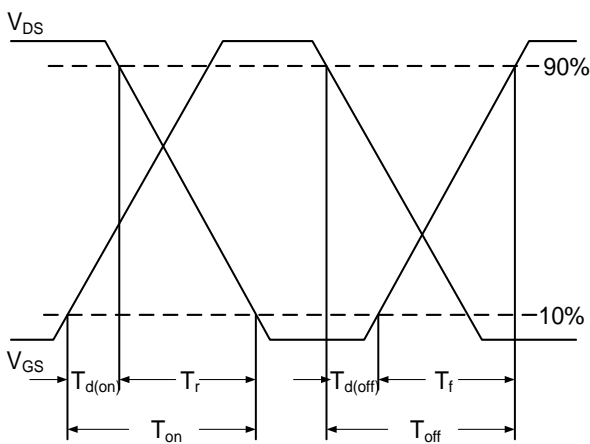

Fig.10 Switching Time Waveform



Fig.11 Unclamped Inductive Switching Waveform