

- ★ 100% EAS Guaranteed
- ★ Green Device Available
- ★ Super Low Gate Charge
- ★ Excellent CdV/dt effect decline
- ★ Advanced high cell density Trench technology

Product Summary

BVDSS	RDSON	ID
30V	4mΩ	110A

Description

The FKP3016 is the high cell density trenched N-ch MOSFETs, which provide excellent RDSON and gate charge for most of the synchronous buck converter applications.

The FKP3016 meet the RoHS and Green Product requirement 100% EAS guaranteed with full function reliability approved.

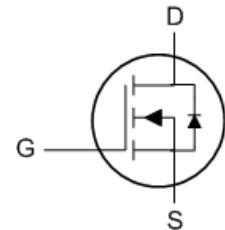
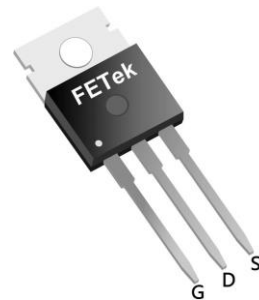
TO220 Pin Configuration

Absolute Maximum Ratings

Symbol	Parameter	Rating	Units
V_{DS}	Drain-Source Voltage	30	V
V_{GS}	Gate-Source Voltage	± 20	V
$I_D@T_C=25^\circ C$	Continuous Drain Current, $V_{GS} @ 10V^1$	110	A
$I_D@T_C=100^\circ C$	Continuous Drain Current, $V_{GS} @ 10V^1$	72	A
$I_D@T_A=25^\circ C$	Continuous Drain Current, $V_{GS} @ 10V^1$	17	A
$I_D@T_A=70^\circ C$	Continuous Drain Current, $V_{GS} @ 10V^1$	14	A
I_{DM}	Pulsed Drain Current ²	225	A
EAS	Single Pulse Avalanche Energy ³	145	mJ
I_{AS}	Avalanche Current	53.8	A
$P_D@T_C=25^\circ C$	Total Power Dissipation ⁴	86.8	W
$P_D@T_A=25^\circ C$	Total Power Dissipation ⁴	2	W
T_{STG}	Storage Temperature Range	-55 to 150	$^\circ C$
T_J	Operating Junction Temperature Range	-55 to 150	$^\circ C$

Thermal Data

Symbol	Parameter	Typ.	Max.	Unit
$R_{\theta JA}$	Thermal Resistance Junction-Ambient ¹	---	62	$^\circ C/W$
$R_{\theta JC}$	Thermal Resistance Junction-Case ¹	---	1.44	$^\circ C/W$



Electrical Characteristics (T_J=25 °C, unless otherwise noted)

Symbol	Parameter	Conditions	Min.	Typ.	Max.	Unit
BV _{DSS}	Drain-Source Breakdown Voltage	V _{GS} =0V , I _D =250uA	30	---	---	V
ΔBV _{DSS} /ΔT _J	BVDSS Temperature Coefficient	Reference to 25°C , I _D =1mA	---	0.0213	---	V/°C
R _{DS(ON)}	Static Drain-Source On-Resistance ²	V _{GS} =10V , I _D =30A	---	---	4	mΩ
		V _{GS} =4.5V , I _D =15A	---	---	6	
V _{GS(th)}	Gate Threshold Voltage	V _{GS} =V _{DS} , I _D =250uA	1.0	---	2.5	V
ΔV _{GS(th)}	V _{GS(th)} Temperature Coefficient		---	-5.73	---	mV/°C
I _{DSS}	Drain-Source Leakage Current	V _{DS} =24V , V _{GS} =0V , T _J =25°C	---	---	1	uA
		V _{DS} =24V , V _{GS} =0V , T _J =55°C	---	---	5	
I _{GSS}	Gate-Source Leakage Current	V _{GS} = ± 20V , V _{DS} =0V	---	---	± 100	nA
g _{fs}	Forward Transconductance	V _{DS} =5V , I _D =30A	---	26.5	---	S
R _g	Gate Resistance	V _{DS} =0V , V _{GS} =0V , f=1MHz	---	1.4	---	Ω
Q _g	Total Gate Charge (4.5V)	V _{DS} =20V , V _{GS} =4.5V , I _D =12A	---	31.6	---	nC
Q _{gs}	Gate-Source Charge		---	6.1	---	
Q _{gd}	Gate-Drain Charge		---	13.8	---	
T _{d(on)}	Turn-On Delay Time	V _{DD} =15V , V _{GS} =10V , R _G =1.5Ω I _D =20A	---	11.2	---	ns
T _r	Rise Time		---	49	---	
T _{d(off)}	Turn-Off Delay Time		---	35	---	
T _f	Fall Time		---	7.8	---	
C _{iss}	Input Capacitance	V _{DS} =15V , V _{GS} =0V , f=1MHz	---	3075	---	pF
C _{oss}	Output Capacitance		---	400	---	
C _{rss}	Reverse Transfer Capacitance		---	315	---	

Diode Characteristics

Symbol	Parameter	Conditions	Min.	Typ.	Max.	Unit
I _S	Continuous Source Current ^{1,5}	V _G =V _D =0V , Force Current	---	---	110	A
I _{SM}	Pulsed Source Current ^{2,5}		---	---	225	A
V _{SD}	Diode Forward Voltage ²	V _{GS} =0V , I _S =1A , T _J =25°C	---	---	1	V

Note :

- 1.The data tested by surface mounted on a 1 inch² FR-4 board with 20Z copper.
- 2.The data tested by pulsed , pulse width ≤ 300us , duty cycle ≤ 2%
- 3.The EAS data shows Max. rating . The test condition is V_{DD}=25V,V_{GS}=10V,L=0.1mH,I_{AS}=53.8A
- 4.The power dissipation is limited by 150°C junction temperature
- 5.The data is theoretically the same as I_D and I_{DM} , in real applications , should be limited by total power dissipation.

Typical Characteristics

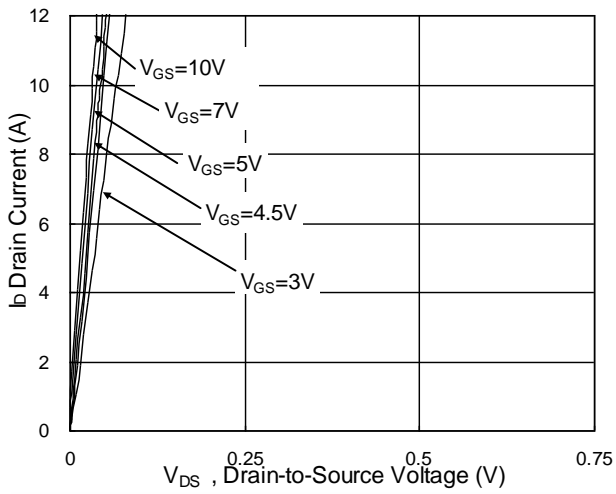

Fig.1 Typical Output Characteristics

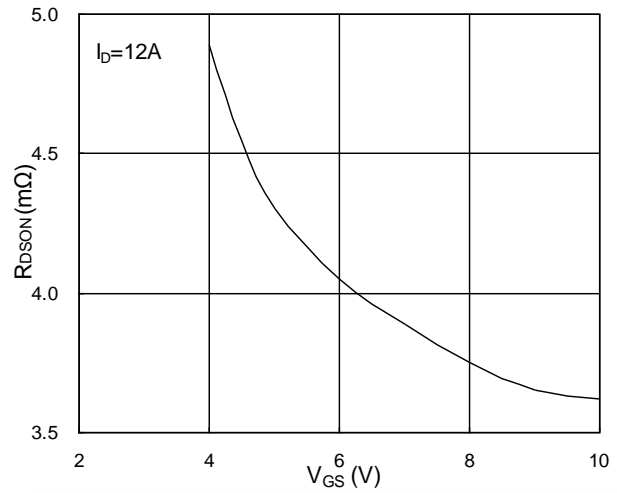

Fig.2 On-Resistance vs. G-S Voltage

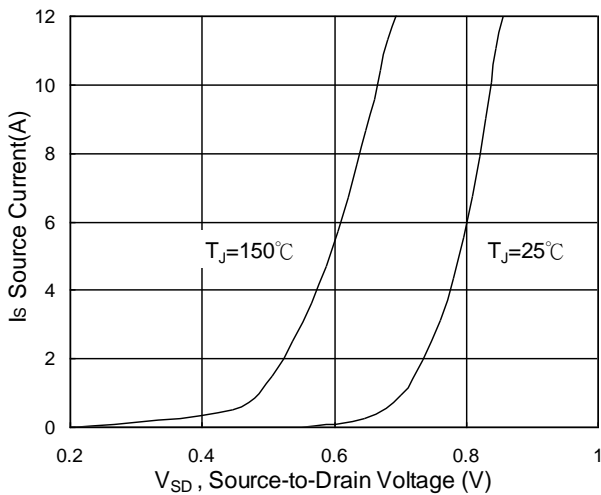

Fig.3 Forward Characteristics of Reverse

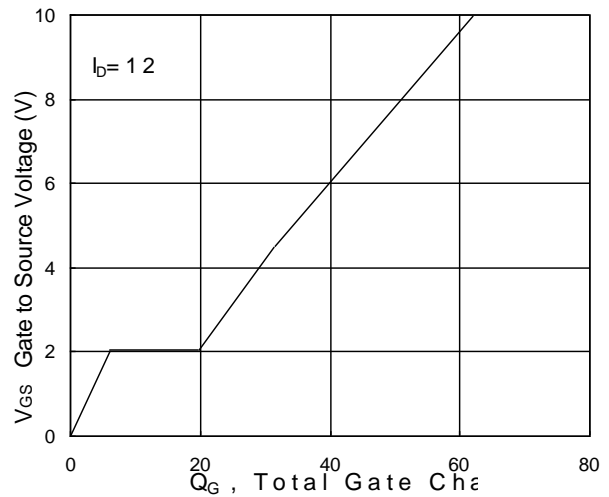

Fig.4 Gate-Charge Characteristics

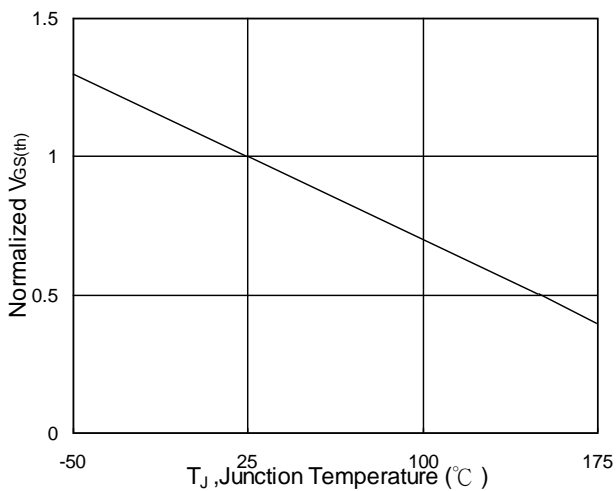

Fig.5 Normalized $V_{GS(th)}$ vs. T_J

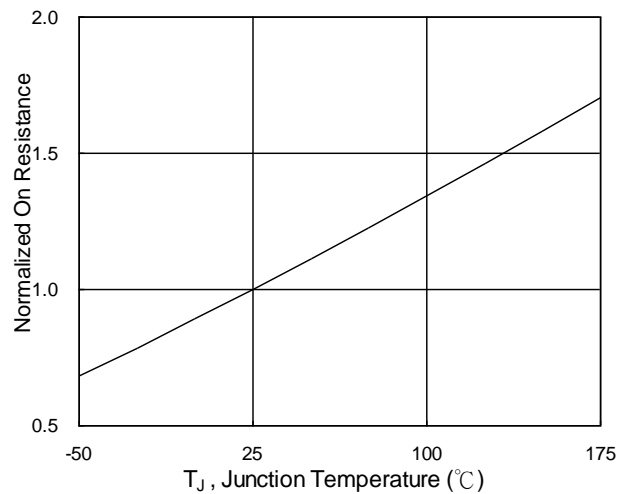

Fig.6 Normalized R_{DSON} vs. T_J

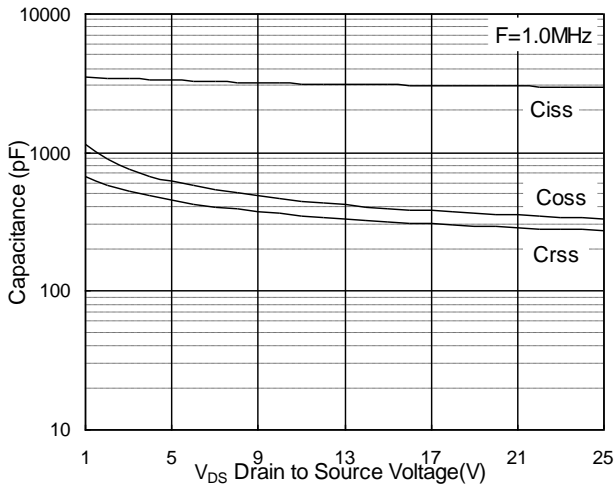

Fig.7 Capacitance

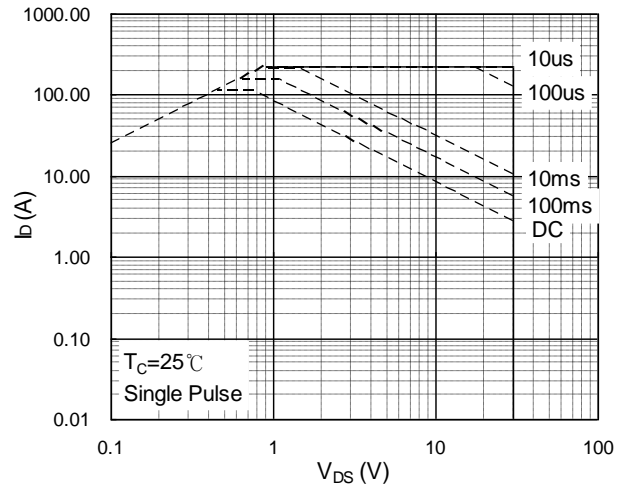

Fig.8 Safe Operating Area

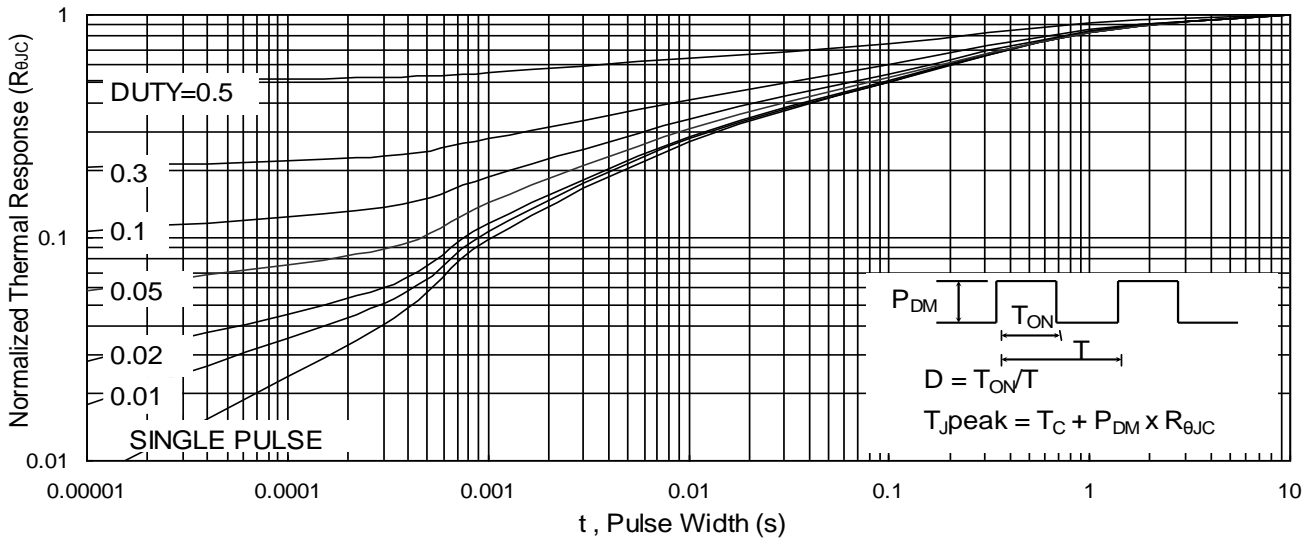

Fig.9 Normalized Maximum Transient Thermal Impedance

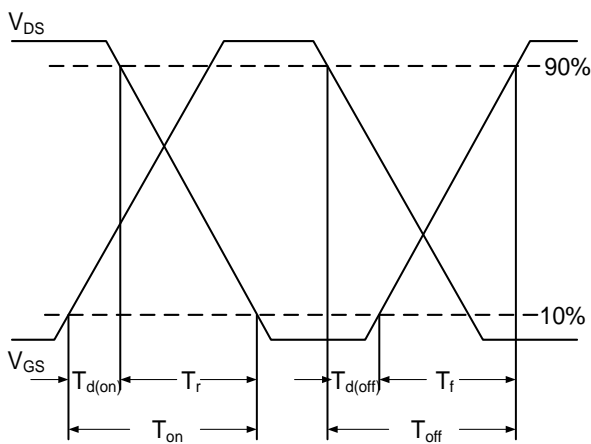

Fig.10 Switching Time Waveform

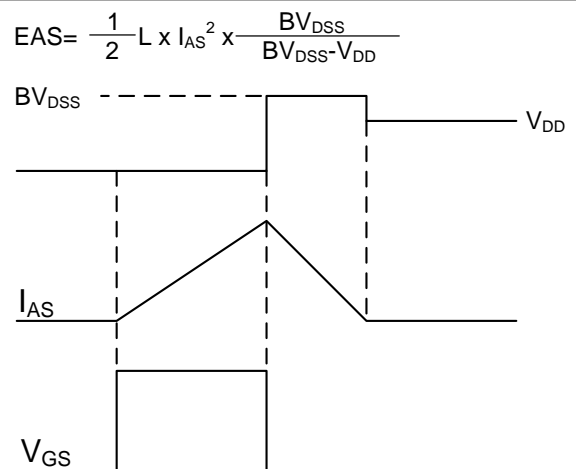

Fig.11 Unclamped Inductive Switching Waveform