

**Features**

- ★ Advanced Trench MOS Technology
- ★ 100% EAS Guaranteed
- ★ Super Low $R_{DS(ON)}$
- ★ Green Device Available

Applications

- ★ MOTOR Driver.
- ★ BMS.
- ★ High frequency switching and synchronous rectification.

Product Summary

BVDSS	RDSON	ID
100V	4.5mΩ	112A

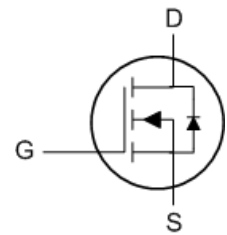
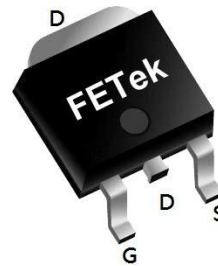
TO252 Pin Configuration**Absolute Maximum Ratings**

Symbol	Parameter	Rating	Units
V_{DS}	Drain-Source Voltage	100	V
V_{GS}	Gate-Source Voltage	± 20	V
$I_D@T_C=25^\circ\text{C}$	Continuous Drain Current, $V_{GS} @ 10V^{1,6}$	112	A
$I_D@T_C=100^\circ\text{C}$	Continuous Drain Current, $V_{GS} @ 10V^{1,6}$	70	A
I_{DM}	Pulsed Drain Current ²	250	A
EAS	Single Pulse Avalanche Energy ³	702	mJ
I_{AS}	Avalanche Current	53	A
$P_D@T_C=25^\circ\text{C}$	Total Power Dissipation ⁴	104	W
T_{STG}	Storage Temperature Range	-55 to 150	$^\circ\text{C}$
T_J	Operating Junction Temperature Range	-55 to 150	$^\circ\text{C}$

Thermal Data

Symbol	Parameter	Typ.	Max.	Unit
$R_{\theta JA}$	Thermal Resistance Junction-Ambient ¹	---	62	$^\circ\text{C/W}$
$R_{\theta JC}$	Thermal Resistance Junction-Case ¹	---	1.2	$^\circ\text{C/W}$



Electrical Characteristics (T_J=25 °C, unless otherwise noted)

Symbol	Parameter	Conditions	Min.	Typ.	Max.	Unit
BV _{DSS}	Drain-Source Breakdown Voltage	V _{GS} =0V, I _D =250μA	100	---	---	V
R _{DS(ON)}	Static Drain-Source On-Resistance ²	V _{GS} =10V, I _D =20A	---	3.9	4.5	mΩ
V _{GS(th)}	Gate Threshold Voltage	V _{GS} =V _{DS} , I _D =250μA	2.0	3.0	4.0	V
I _{DSS}	Drain-Source Leakage Current	V _{DS} =100V, V _{GS} =0V, T _J =25°C	---	---	1	μA
		V _{DS} =100V, V _{GS} =0V, T _J =125°C	---	---	10	
I _{GSS}	Gate-Source Leakage Current	V _{GS} =±20V, V _{DS} =0V	---	---	±100	nA
g _{fs}	Forward Transconductance	V _{DS} =5V, I _D =30A	---	50	---	S
R _g	Gate Resistance	V _{DS} =0V, V _{GS} =0V, f=1MHz	---	1	---	Ω
Q _g	Total Gate Charge (10V)	V _{DS} =50V, V _{GS} =10V, I _D =20A	---	72	---	nC
Q _{gs}	Gate-Source Charge		---	28	---	
Q _{gd}	Gate-Drain Charge		---	15	---	
T _{d(on)}	Turn-On Delay Time	V _{DD} =50V, V _{GS} =10V, R _G =3.3Ω, I _D =30A	---	19	---	ns
T _r	Rise Time		---	53	---	
T _{d(off)}	Turn-Off Delay Time		---	37	---	
T _f	Fall Time		---	48	---	
C _{iss}	Input Capacitance	V _{DS} =50V, V _{GS} =0V, f=1MHz	---	4725	---	pF
C _{oss}	Output Capacitance		---	609	---	
C _{rss}	Reverse Transfer Capacitance		---	14	---	

Diode Characteristics

Symbol	Parameter	Conditions	Min.	Typ.	Max.	Unit
I _S	Continuous Source Current ^{1,5}	V _G =V _D =0V, Force Current	---	---	112	A
V _{SD}	Diode Forward Voltage ²	V _{GS} =0V, I _S =20A, T _J =25°C	---	---	1.3	V
t _{rr}	Reverse Recovery Time	I _F =30A, di/dt=100A/μs,	---	70	---	nS
Q _{rr}	Reverse Recovery Charge	T _J =25°C	---	170	---	

Note :

- 1.The data tested by surface mounted on a 1 inch² FR-4 board with 2OZ copper.
- 2.The data tested by pulsed, pulse width ≤ 300us, duty cycle ≤ 2%
- 3.The EAS data shows Max. rating. The test condition is V_{DD}=25V, V_{GS}=10V, L=0.5mH, I_{AS}=53A
- 4.The power dissipation is limited by 150°C junction temperature
- 5.The data is theoretically the same as I_D and I_{DM}, in real applications, should be limited by total power dissipation.
- 6.Bonding wire limitation current is 85A.

Typical Characteristics

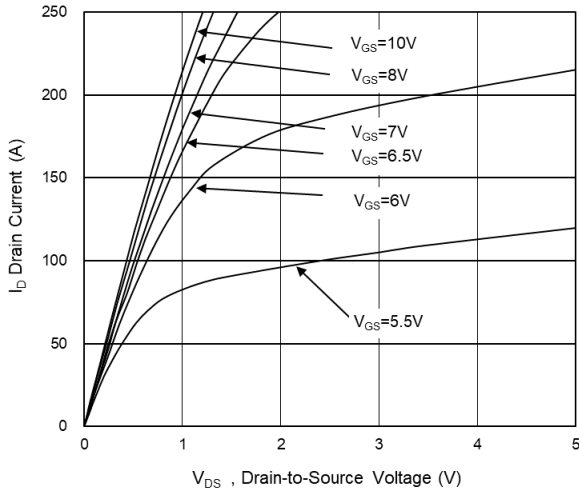

Fig.1 Typical Output Characteristics

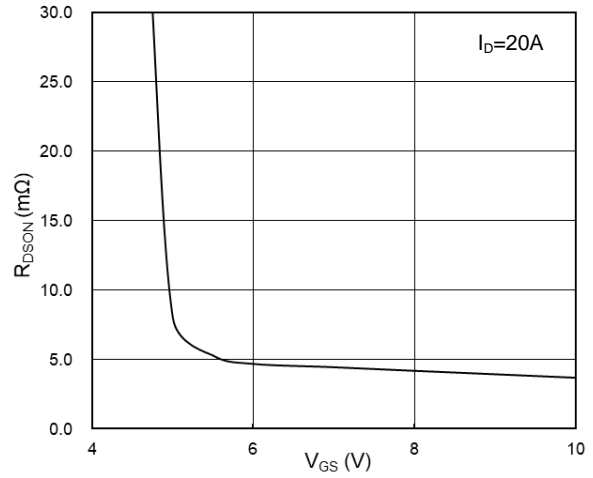

Fig.2 On-Resistance vs G-S Voltage

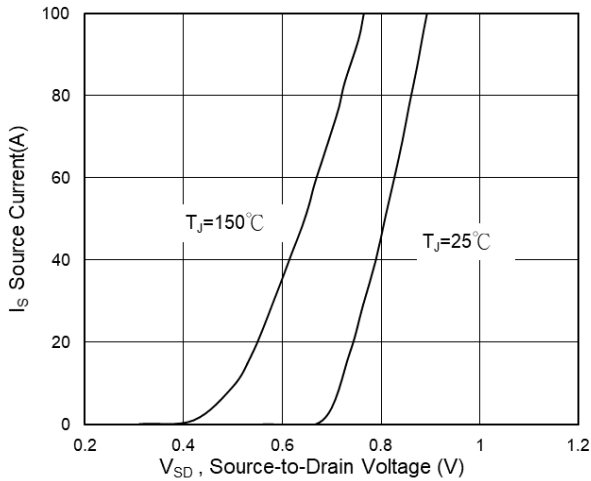

Fig.3 Source Drain Forward Characteristics

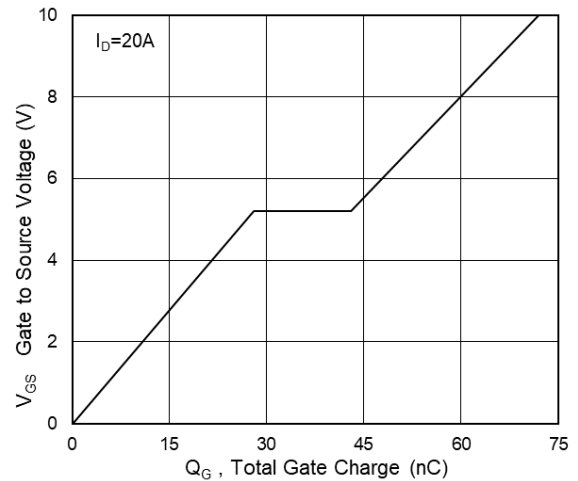

Fig.4 Gate-Charge Characteristics

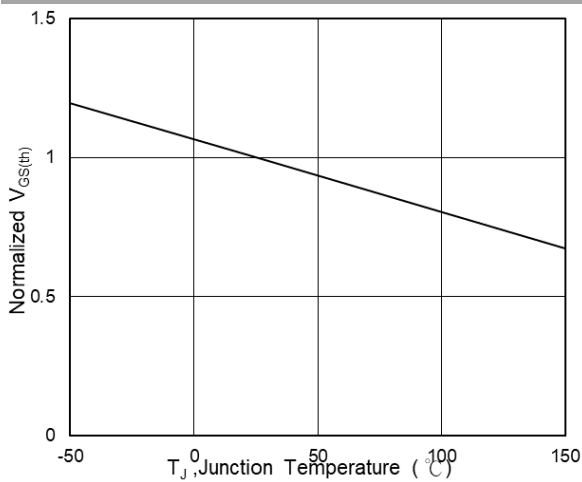

Fig.5 Normalized V_{TH} vs T_J

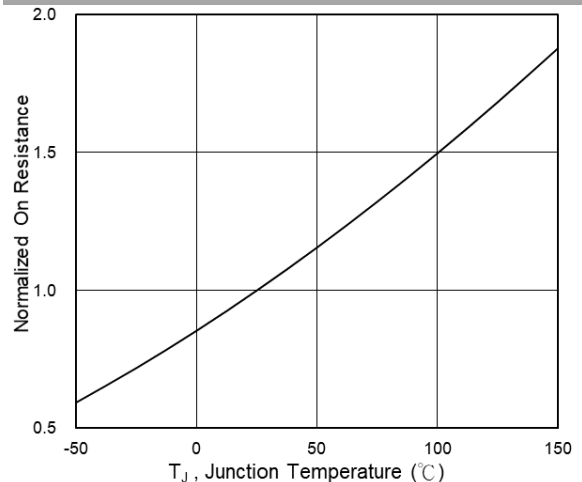

Fig.6 Normalized $R_{DS(on)}$ vs T_J

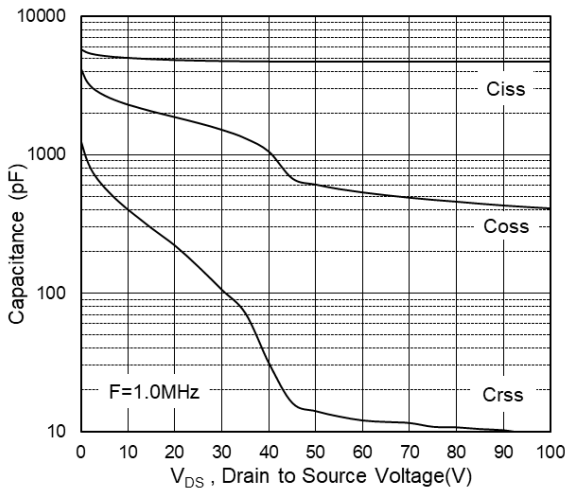

Fig.7 Capacitance

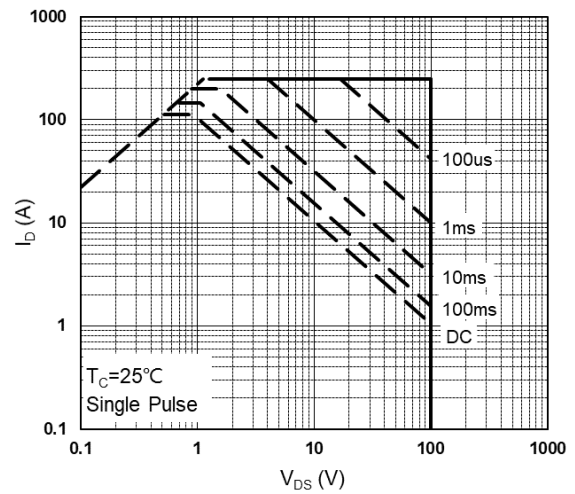

Fig.8 Safe Operating Area

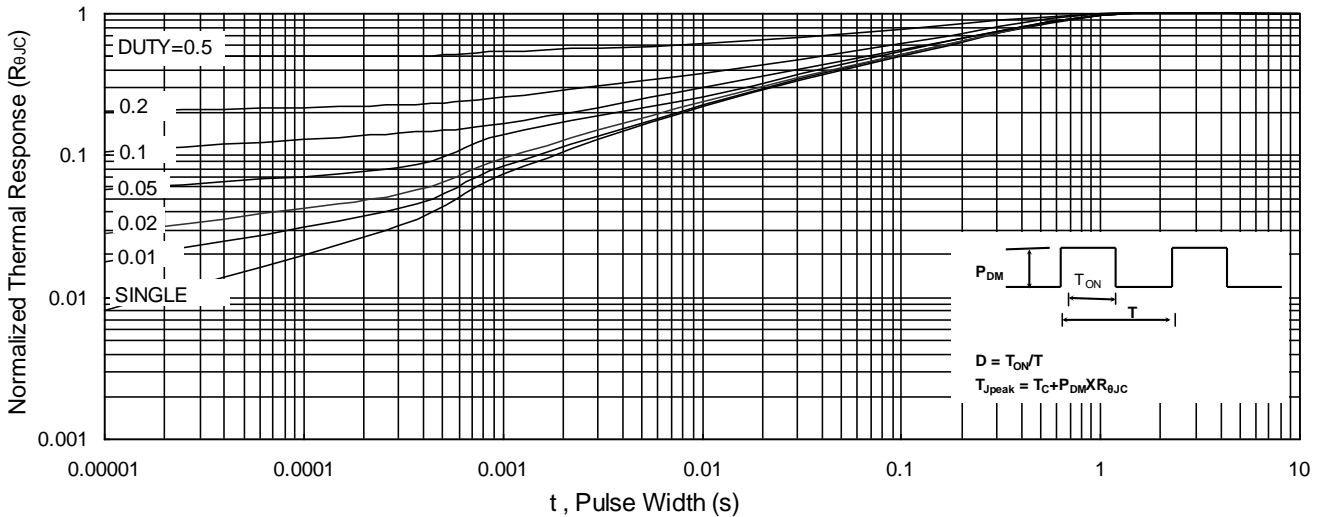

Fig.9 Normalized Maximum Transient Thermal Impedance



Fig.10 Switching Time Waveform

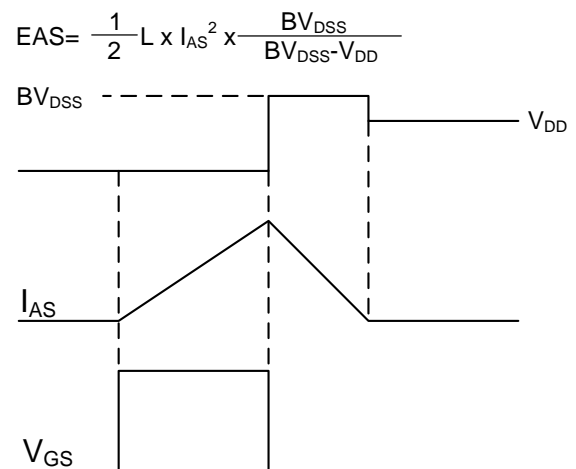

Fig.11 Unclamped Inductive Switching Waveform