

- ★ 100% EAS Guaranteed
- ★ Green Device Available
- ★ Super Low Gate Charge
- ★ Excellent CdV/dt effect decline
- ★ Advanced high cell density Trench technology

**Product Summary**

BVDSS	RDSON	ID
40V	6.5mΩ	40A

**Description**

The FKBB4016 is the high cell density trenched N-ch MOSFETs, which provide excellent RDSON and gate charge for most of the synchronous buck converter applications.

The FKBB4016 meet the RoHS and Green Product requirement 100% EAS guaranteed with full function reliability approved.

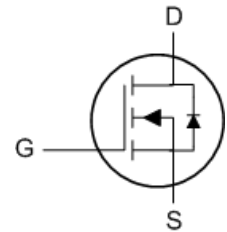
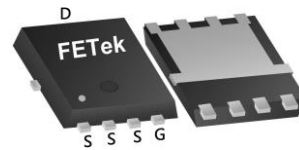
**PRPAK3X3 Pin Configuration**

**Absolute Maximum Ratings**

Symbol	Parameter	Rating	Units
$V_{DS}$	Drain-Source Voltage	40	V
$V_{GS}$	Gate-Source Voltage	$\pm 20$	V
$I_D @ T_C = 25^\circ C$	Continuous Drain Current, $V_{GS} @ 10V^1$	40	A
$I_D @ T_C = 100^\circ C$	Continuous Drain Current, $V_{GS} @ 10V^1$	31	A
$I_{DM}$	Pulsed Drain Current <sup>2</sup>	140	A
EAS	Single Pulse Avalanche Energy <sup>3</sup>	101	mJ
$I_{AS}$	Avalanche Current	45	A
$P_D @ T_C = 25^\circ C$	Total Power Dissipation <sup>4</sup>	36.7	W
$T_{STG}$	Storage Temperature Range	-55 to 150	$^\circ C$
$T_J$	Operating Junction Temperature Range	-55 to 150	$^\circ C$

**Thermal Data**

Symbol	Parameter	Typ.	Max.	Unit
$R_{\theta JA}$	Thermal Resistance Junction-Ambient <sup>1</sup>	---	75	$^\circ C/W$
$R_{\theta JC}$	Thermal Resistance Junction-Case <sup>1</sup>	---	3.4	$^\circ C/W$

**Electrical Characteristics ( $T_J=25^\circ\text{C}$ , unless otherwise noted)**

Symbol	Parameter	Conditions	Min.	Typ.	Max.	Unit
$BV_{DSS}$	Drain-Source Breakdown Voltage	$V_{GS}=0V, I_D=250\mu A$	40	---	---	V
$R_{DS(ON)}$	Static Drain-Source On-Resistance <sup>2</sup>	$V_{GS}=10V, I_D=10A$	---	5	6.5	m $\Omega$
		$V_{GS}=4.5V, I_D=5A$	---	6.5	9	
$V_{GS(th)}$	Gate Threshold Voltage	$V_{GS}=V_{DS}, I_D=250\mu A$	1.0	---	2.5	V
$I_{DSS}$	Drain-Source Leakage Current	$V_{DS}=32V, V_{GS}=0V, T_J=25^\circ\text{C}$	---	---	1	$\mu A$
		$V_{DS}=32V, V_{GS}=0V, T_J=55^\circ\text{C}$	---	---	5	
$I_{GSS}$	Gate-Source Leakage Current	$V_{GS}=\pm 20V, V_{DS}=0V$	---	---	$\pm 100$	nA
$g_{fs}$	Forward Transconductance	$V_{DS}=5V, I_D=5A$	---	27	---	S
$Q_g$	Total Gate Charge (4.5V)	$V_{DS}=20V, V_{GS}=4.5V, I_D=10A$	---	20	---	nC
$Q_{gs}$	Gate-Source Charge		---	5.8	---	
$Q_{gd}$	Gate-Drain Charge		---	9.5	---	
$T_{d(on)}$	Turn-On Delay Time	$V_{DD}=15V, V_{GS}=10V, R_G=3.3\Omega$ $I_D=1A$	---	15.2	---	ns
$T_r$	Rise Time		---	8.8	---	
$T_{d(off)}$	Turn-Off Delay Time		---	74	---	
$T_f$	Fall Time		---	7	---	
$C_{iss}$	Input Capacitance	$V_{DS}=15V, V_{GS}=0V, f=1\text{MHz}$	---	2354	---	pF
$C_{oss}$	Output Capacitance		---	215	---	
$C_{rss}$	Reverse Transfer Capacitance		---	175	---	

**Diode Characteristics**

Symbol	Parameter	Conditions	Min.	Typ.	Max.	Unit
$I_S$	Continuous Source Current <sup>1,5</sup>	$V_G=V_D=0V$ , Force Current	---	---	40	A
$V_{SD}$	Diode Forward Voltage <sup>2</sup>	$V_{GS}=0V, I_S=1A, T_J=25^\circ\text{C}$	---	---	1	V

Note :

- 1.The data tested by surface mounted on a 1 inch<sup>2</sup> FR-4 board with 2OZ copper.
- 2.The data tested by pulsed , pulse width  $\leq 300\mu s$ , duty cycle  $\leq 2\%$
- 3.The EAS data shows Max. rating . The test condition is  $V_{DD}=25V, V_{GS}=10V, L=0.1mH, I_{AS}=45A$
- 4.The power dissipation is limited by  $150^\circ\text{C}$  junction temperature
- 5.The data is theoretically the same as  $I_D$  and  $I_{DM}$ , in real applications , should be limited by total power dissipation.

**Typical Characteristics**

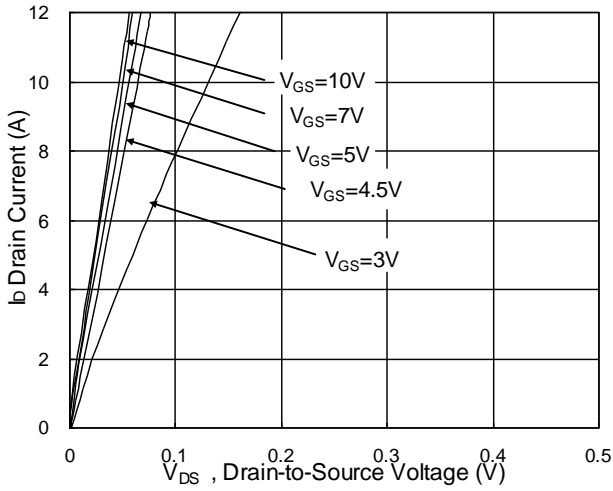

**Fig.1 Typical Output Characteristics**

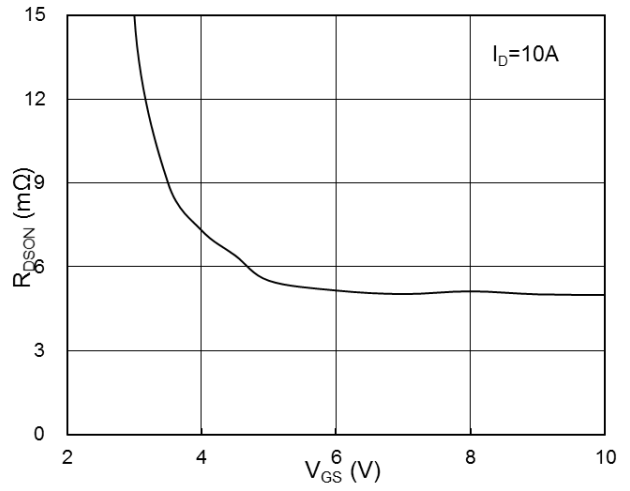

**Fig.2 On-Resistance vs. G-S Voltage**

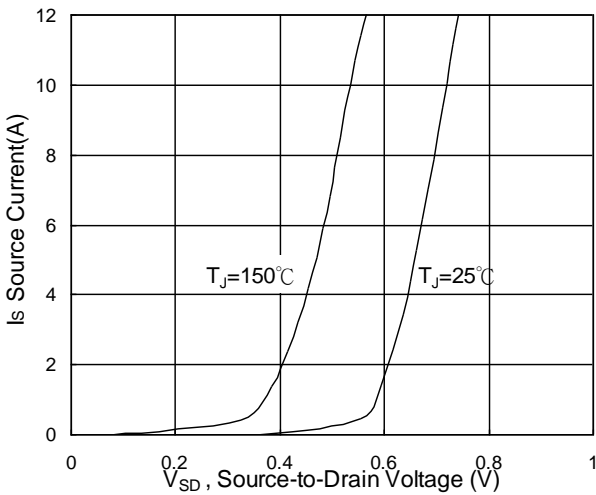

**Fig.3 Source Drain Forward Characteristics**

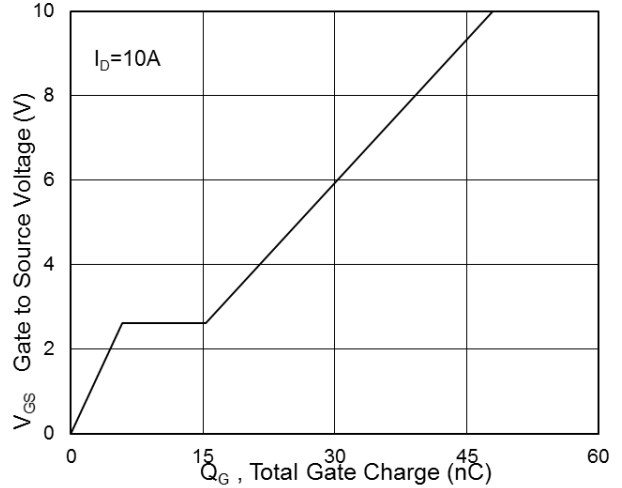

**Fig.4 Gate-Charge Characteristics**

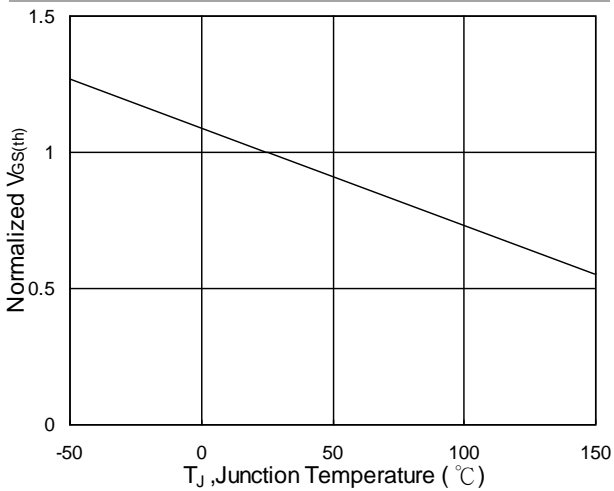

**Fig.5 Normalized  $V_{GS(th)}$  vs.  $T_J$**

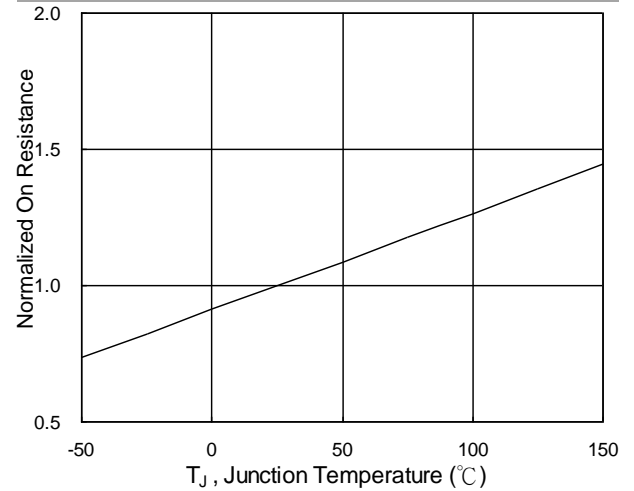

**Fig.6 Normalized  $R_{DS(on)}$  vs.  $T_J$**

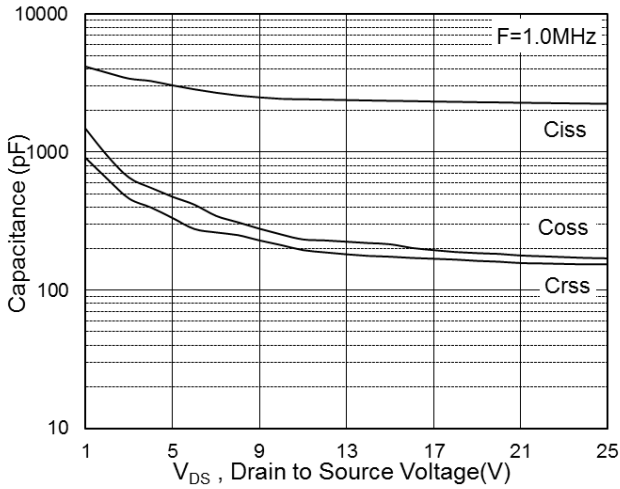

Fig.7 Capacitance

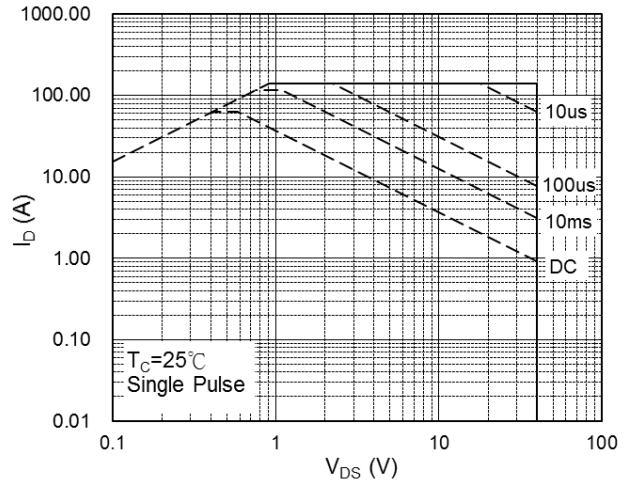

Fig.8 Safe Operating Area

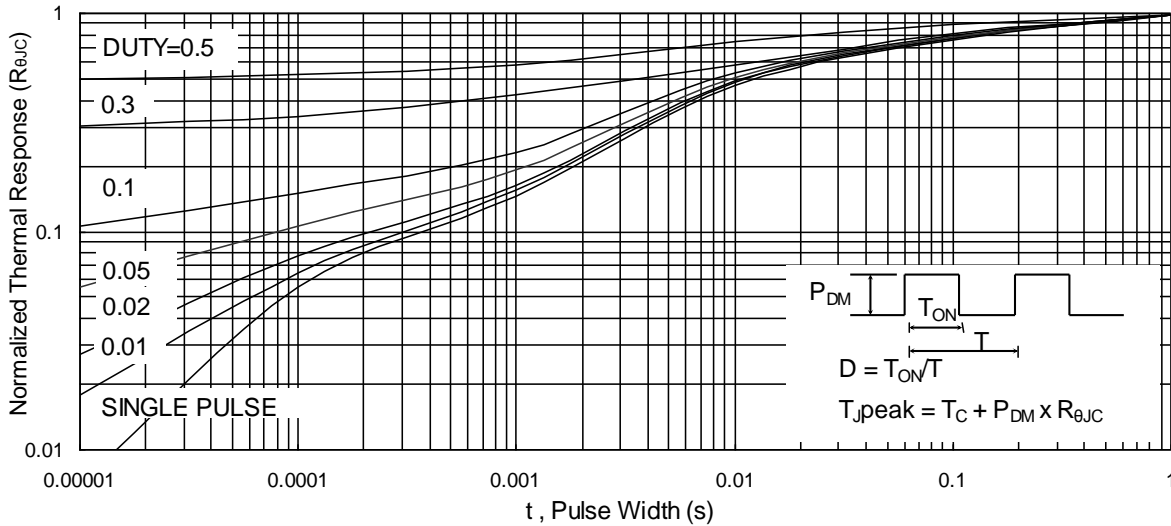

Fig.9 Normalized Maximum Transient Thermal Impedance

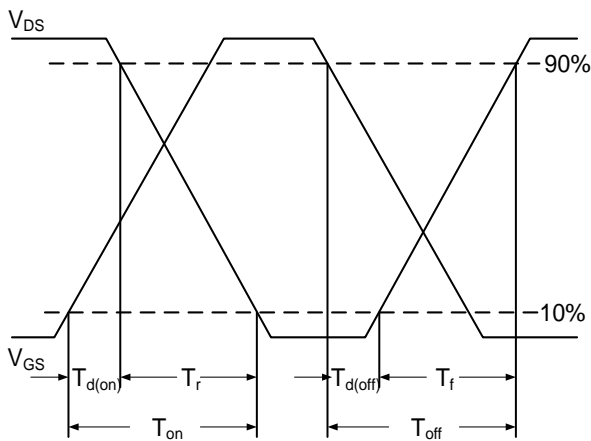

Fig.10 Switching Time Waveform

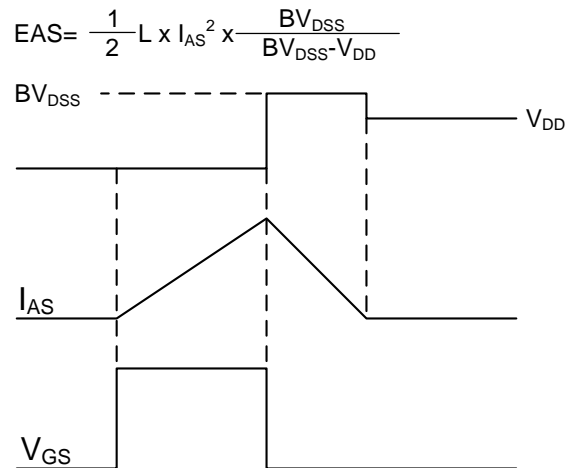
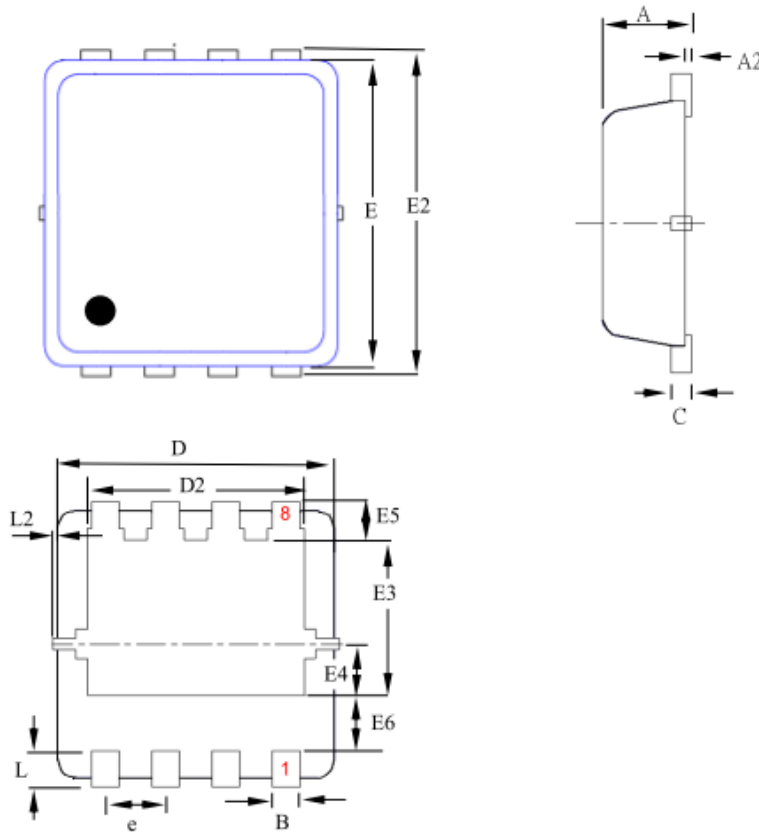

Fig.11 Unclamped Inductive Switching Wave

## PRPAK3X3 Package Outline Dimensions



SYMBOLS	MILLIMETERS			INCHES		
	MIN	NOM	MAX	MIN	NOM	MAX
A	0.70	0.80	0.90	0.028	0.031	0.035
A2	0.00	--	0.05	0.000	--	0.002
B	0.24	0.30	0.35	0.009	0.012	0.014
C	0.10	0.15	0.25	0.004	0.006	0.010
D	2.90	3.00	3.20	0.114	0.118	0.126
D2	2.15	2.35	2.59	0.085	0.093	0.102
E	2.90	3.00	3.12	0.114	0.118	0.123
E2	3.05	3.20	3.45	0.120	0.126	0.136
E3	1.55	1.75	1.95	0.061	0.069	0.077
E4	0.48	0.58	0.68	0.019	0.023	0.027
E5	0.28	0.43	0.58	0.011	0.017	0.023
E6	0.43	0.63	0.87	0.017	0.025	0.034
L	0.30	0.40	0.50	0.012	0.016	0.020
L2	0.00	--	0.10	0.000	--	0.004
e	--	0.65	--	--	0.026	--

## Marking Instruction

