



## N-Ch 80V Fast Switching MOSFETs

- ★ 100% EAS Guaranteed
- ★ Green Device Available
- ★ Super Low Gate Charge
- ★ Excellent CdV/dt effect decline
- ★ Advanced high cell density Trench technology

## Product Summary



BVDSS	RDSON	ID
80V	6.5mΩ	122A

## Description

The FKBA8024A is the high cell density trenched N-ch MOSFETs, which provide excellent RDSON and gate charge for most of the synchronous buck converter applications.

The FKBA8024A meet the RoHS and Green Product requirement, 100% EAS guaranteed with full function reliability approved.

## PRPAK5X6 Pin Configuration

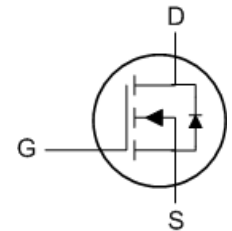
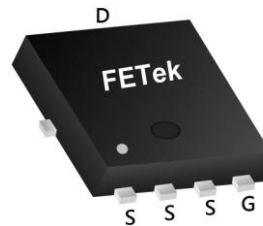

## Absolute Maximum Ratings

Symbol	Parameter	Rating	Units
$V_{DS}$	Drain-Source Voltage	80	V
$V_{GS}$	Gate-Source Voltage	$\pm 20$	V
$I_D@T_C=25^\circ C$	Continuous Drain Current, $V_{GS} @ 10V^{1,6}$	122	A
$I_D@T_C=100^\circ C$	Continuous Drain Current, $V_{GS} @ 10V^{1,6}$	78.6	A
$I_{DM}$	Pulsed Drain Current <sup>2</sup>	300	A
EAS	Single Pulse Avalanche Energy <sup>3</sup>	246.4	mJ
$I_{AS}$	Avalanche Current	70.2	A
$P_D@T_C=25^\circ C$	Total Power Dissipation <sup>4</sup>	156	W
$T_{STG}$	Storage Temperature Range	-55 to 150	$^\circ C$
$T_J$	Operating Junction Temperature Range	-55 to 150	$^\circ C$

## Thermal Data

Symbol	Parameter	Typ.	Max.	Unit
$R_{\theta JA}$	Thermal Resistance Junction-Ambient <sup>1</sup>	---	62	$^\circ C/W$
$R_{\theta JC}$	Thermal Resistance Junction-Case <sup>1</sup>	---	0.8	$^\circ C/W$

**Electrical Characteristics ( $T_J=25\text{ }^\circ\text{C}$ , unless otherwise noted)**

Symbol	Parameter	Conditions	Min.	Typ.	Max.	Unit
$BV_{DSS}$	Drain-Source Breakdown Voltage	$V_{GS}=0V, I_D=250\mu A$	80	---	---	V
$\Delta BV_{DSS}/\Delta T_J$	$BV_{DSS}$ Temperature Coefficient	Reference to $25\text{ }^\circ\text{C}$ , $I_D=1mA$	---	0.059	---	$V/^\circ\text{C}$
$R_{DS(ON)}$	Static Drain-Source On-Resistance <sup>2</sup>	$V_{GS}=10V, I_D=30A$	---	---	6.5	$m\Omega$
$V_{GS(th)}$	Gate Threshold Voltage	$V_{GS}=V_{DS}, I_D=250\mu A$	2	---	4	V
$\Delta V_{GS(th)}$	$V_{GS(th)}$ Temperature Coefficient		---	-4.6	---	$mV/^\circ\text{C}$
$I_{DSS}$	Drain-Source Leakage Current	$V_{DS}=64V, V_{GS}=0V, T_J=25\text{ }^\circ\text{C}$	---	---	1	$\mu A$
		$V_{DS}=64V, V_{GS}=0V, T_J=55\text{ }^\circ\text{C}$	---	---	5	
$I_{GSS}$	Gate-Source Leakage Current	$V_{GS}=\pm 20V, V_{DS}=0V$	---	---	$\pm 100$	nA
gfs	Forward Transconductance	$V_{DS}=5V, I_D=30A$	---	50	---	S
$R_g$	Gate Resistance	$V_{DS}=0V, V_{GS}=0V, f=1MHz$	---	1.4	---	$\Omega$
$Q_g$	Total Gate Charge (10V)	$V_{DS}=64V, V_{GS}=10V, I_D=30A$	---	83.7	---	nC
$Q_{gs}$	Gate-Source Charge		---	28.6	---	
$Q_{gd}$	Gate-Drain Charge		---	29.3	---	
$T_d(on)$	Turn-On Delay Time	$V_{DD}=40V, V_{GS}=10V, R_G=3.3\Omega, I_D=30A$	---	38.1	---	ns
$T_r$	Rise Time		---	73.3	---	
$T_d(off)$	Turn-Off Delay Time		---	51.6	---	
$T_f$	Fall Time		---	26.1	---	
$C_{iss}$	Input Capacitance	$V_{DS}=15V, V_{GS}=0V, f=1MHz$	---	5580	---	$\mu F$
$C_{oss}$	Output Capacitance		---	571	---	
$C_{rss}$	Reverse Transfer Capacitance		---	278	---	

**Diode Characteristics**

Symbol	Parameter	Conditions	Min.	Typ.	Max.	Unit
$I_S$	Continuous Source Current <sup>1,5</sup>	$V_G=V_D=0V$ , Force Current	---	---	122	A
$I_{SM}$	Pulsed Source Current <sup>2,5</sup>		---	---	300	A
$V_{SD}$	Diode Forward Voltage <sup>2</sup>	$V_{GS}=0V, I_S=A, T_J=25\text{ }^\circ\text{C}$	---	---	1.2	V
$t_{rr}$	Reverse Recovery Time	$I_F=30A, di/dt=100A/\mu s, T_J=25\text{ }^\circ\text{C}$	---	26.7	---	nS
$Q_{rr}$	Reverse Recovery Charge		---	27.9	---	nC

Note :

- 1.The data tested by surface mounted on a 1 inch<sup>2</sup> FR-4 board with 2OZ copper.
- 2.The data tested by pulsed , pulse width  $\leq 300\mu s$  , duty cycle  $\leq 2\%$
- 3.The EAS data shows Max. rating . The test condition is  $V_{DD}=25V, V_{GS}=10V, L=0.1mH, I_{AS}=70.2A$
- 4.The power dissipation is limited by  $150\text{ }^\circ\text{C}$  junction temperature
- 5.The data is theoretically the same as  $I_D$  and  $I_{DM}$  , in real applications , should be limited by total power dissipation.
- 6.Package limitation current is 90A.

**Typical Characteristics**

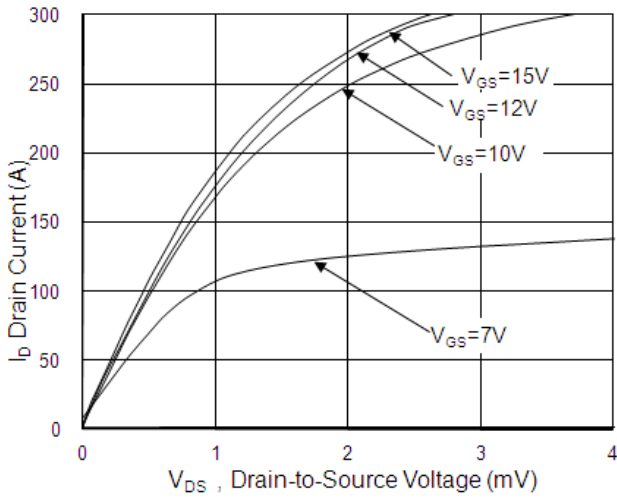

**Fig.1 Typical Output Characteristics**

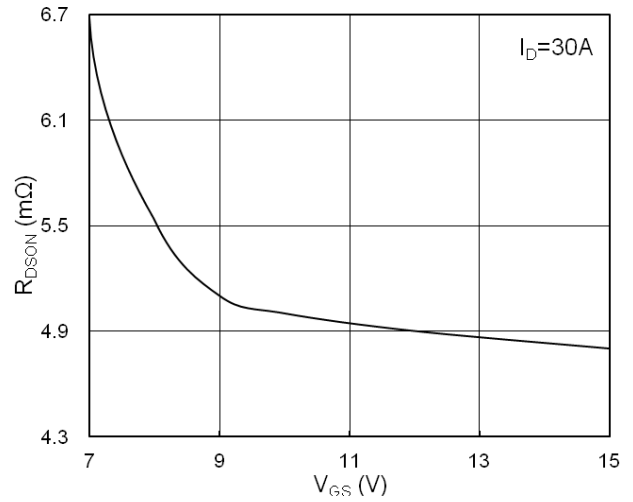

**Fig.2 On-Resistance v.s Gate-Source**

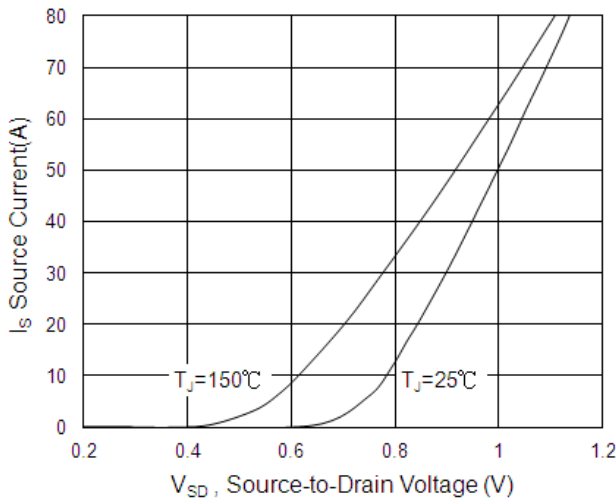

**Fig.3 Forward Characteristics of Reverse**

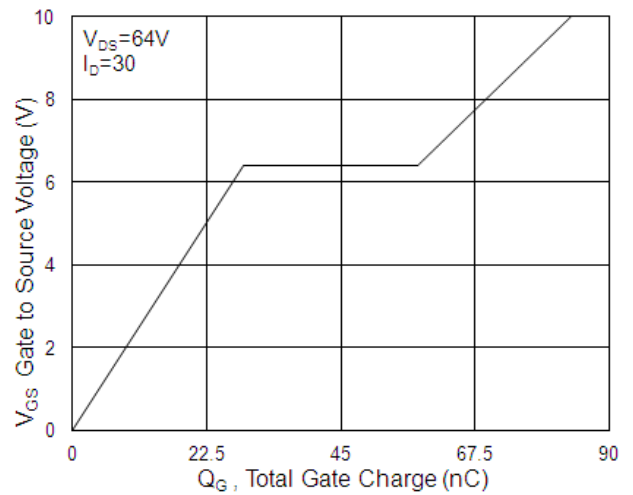

**Fig.4 Gate-Charge Characteristics**

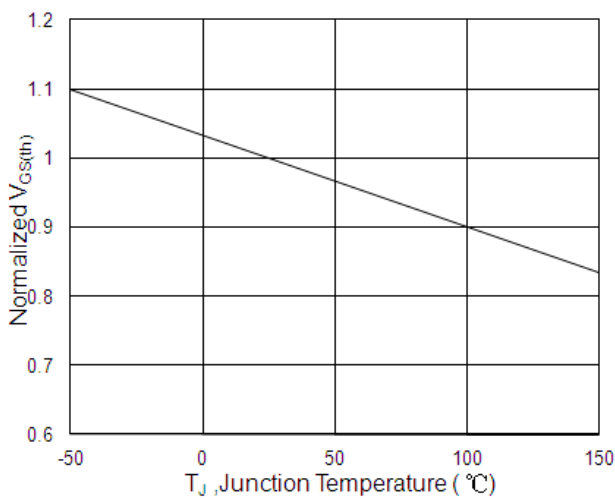

**Fig.5 Normalized  $V_{GS(th)}$  vs.  $T_J$**

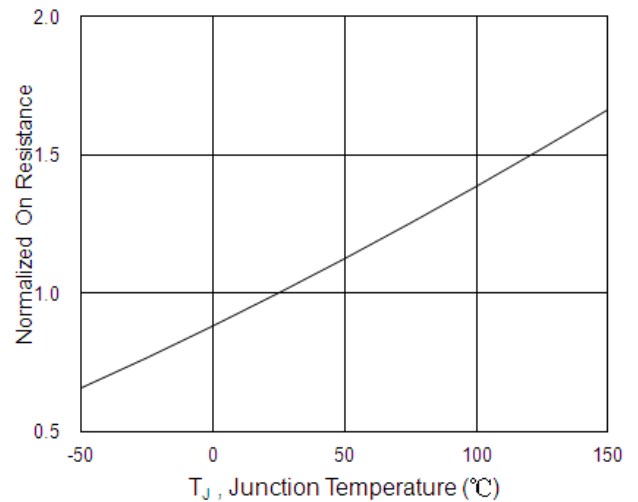

**Fig.6 Normalized  $R_{DS(on)}$  vs.  $T_J$**

N-Ch 80V Fast Switching MOSFETs

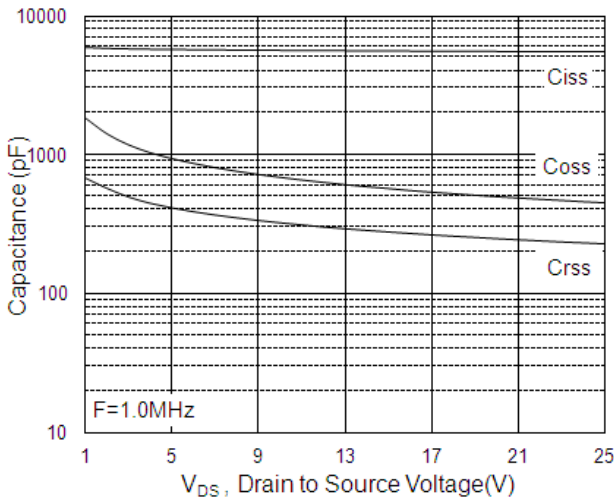

Fig.7 Capacitance

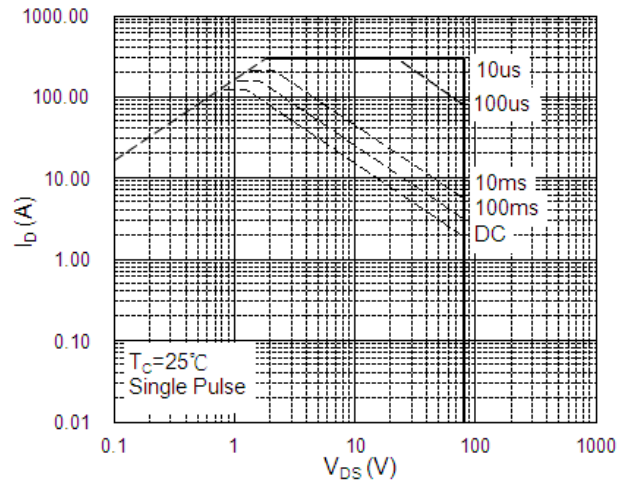

Fig.8 Safe Operating Area

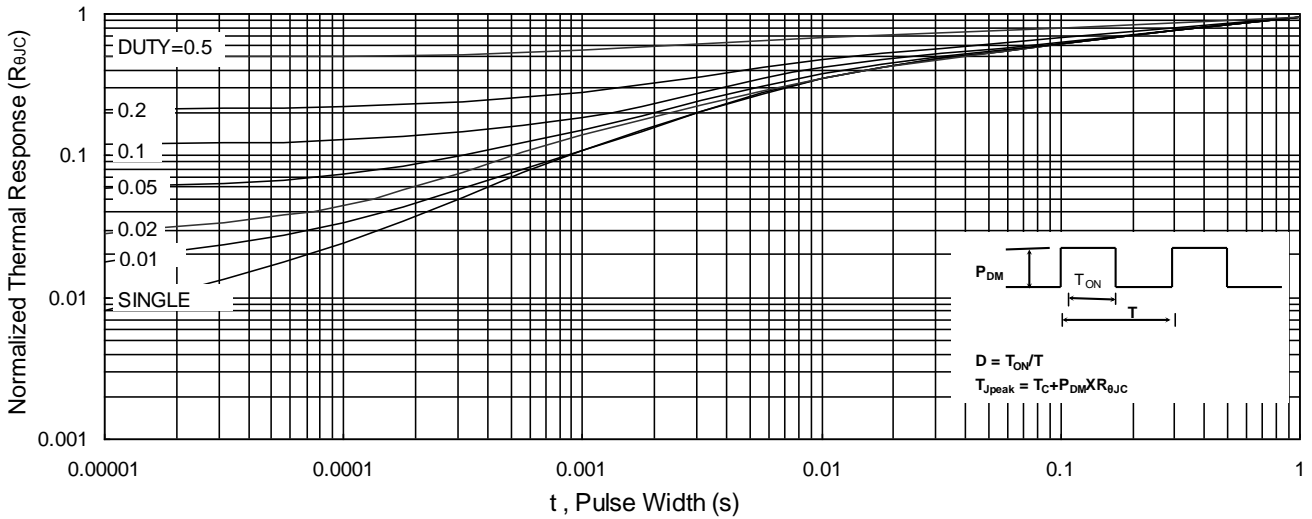

Fig.9 Normalized Maximum Transient Thermal Impedance

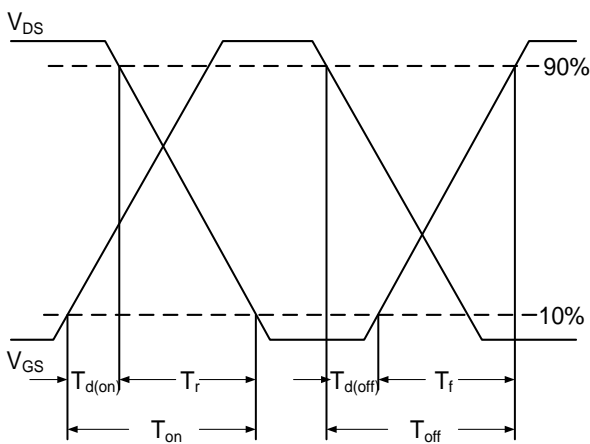

Fig.10 Switching Time Waveform

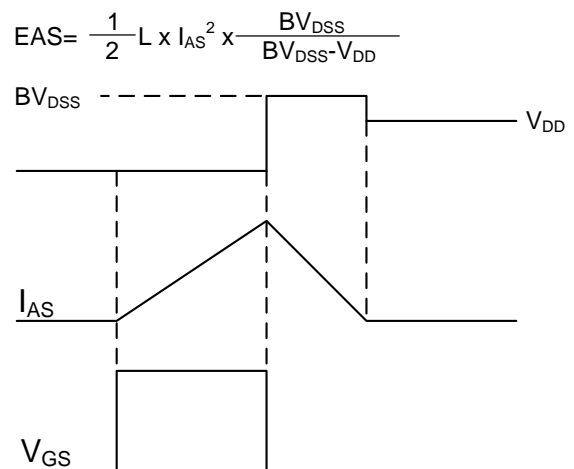

Fig.11 Unclamped Inductive Switching Waveform